



**2 0 2 4**

El 100% de  
nuestro consumo  
eléctrico proviene  
de energías  
renovables.

2.128 paneles solares proporcionan a nuestra fábrica de Burgos el 15% de la electricidad consumida.

En Gala cuidamos del entorno que nos rodea y queremos asegurar el futuro de las siguientes generaciones.

Gala cerca de ti.

**gala**



## 50 años **innovando**

Hoy somos el futuro que imaginamos en 1965 porque nuestros valores no han cambiado, con un servicio cualificado y siempre el mejor equipo humano.

Valores que llevamos con la marca Gala a más de 60 países de los cinco continentes.

A close-up photograph of a person's hand holding a white plastic container. The word "gala" is printed in a dark, lowercase, sans-serif font on the side of the container. The background is blurred, showing what appears to be a patterned fabric or surface.

gala



## Fabricando **calidad**

La calidad es nuestro sello, por eso la certificamos. Excelencia en el desarrollo de nuestros productos, investigación, exigencia y diseño, han hecho a Gala pionera en la obtención de las más prestigiosas certificaciones y homologaciones nacionales e internacionales. Gala es sinónimo de calidad española en todos los países en los que opera.



# Índice

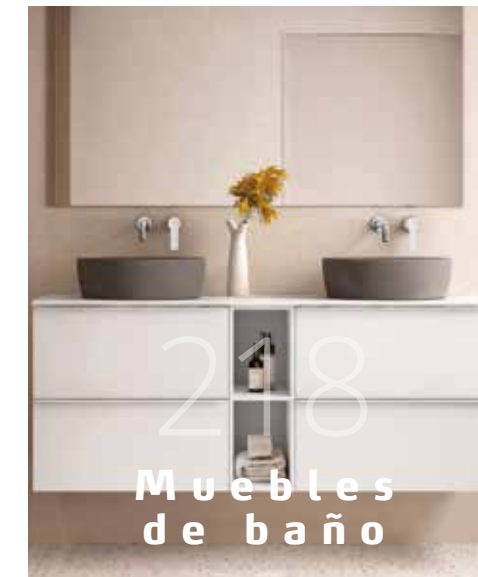

# Índice

008

SHOWER TOILET

Gala Innova <small>galá/IP</small>	<b>008</b>
<hr/>	
Infantil	
Baby wc	<b>134</b>
Movilidad reducida	
Blue	<b>138</b>

016

COLECCIONES DE BAÑO

Noble <small>galá/IP</small>	<b>022</b>	Asientos para colecciones descatalogadas	
Eos <small>galá/IP</small>	<b>028</b>		
Coral <small>galá/IP</small>	<b>036</b>	Gala 2000	<b>142</b>
Emma Square <small>galá/IP</small>	<b>044</b>	Diana	<b>142</b>
<sup>N</sup> Emma <small>galá/IP</small>	<b>058</b>	Aurea	<b>142</b>
Mid	<b>074</b>	Bacara	<b>142</b>
Smart	<b>084</b>	Nostalgia	<b>142</b>
Street Square	<b>094</b>	Marina	<b>142</b>
<sup>N</sup> Aris	<b>104</b>	Arq.	<b>142</b>
Elia	<b>114</b>	Universal	<b>143</b>
<sup>N</sup> Lizz	<b>124</b>	Jazz	<b>143</b>
		Loa	<b>144</b>
		Metropol	<b>144</b>
		Street	<b>144</b>
		Elia	<b>144</b>
		Stylo	<b>144</b>
		Duna	<b>144</b>
		Nexo	<b>144</b>
		Klea	<b>145</b>
		Emma	<b>145</b>
		Emma Square	<b>145</b>

146

SISTEMAS Y MECANISMOS

Soportes	
Eon	<b>148</b>
Stride	<b>158</b>
Pulsadores	
Eon 8	<b>150</b>
Eon 9	<b>151</b>
Eon 3	<b>152</b>
<sup>N</sup> Eon 11	<b>154</b>
Eon Electrónica	<b>156</b>
Slot	<b>157</b>
ST2	<b>160</b>
ST4	<b>161</b>
Mecanismos de descarga encajados	<b>162</b>

164

LAVABOS

<b>+Design</b>	
<sup>N</sup> Hera	<b>173</b>
Klea <small>galá/IP</small>	<b>178</b>
Emma Square <small>galá/IP</small>	<b>180</b>
Urban	<b>182</b>
Soft	<b>185</b>
Slim <small>galá/IP</small>	<b>186</b>
Albus <small>galá/IP</small>	<b>188</b>
Bowl	<b>192</b>
Circle	<b>194</b>
Casual	<b>195</b>
Lavabos encimera	
Óvalo	<b>197</b>
Emma Square <small>galá/IP</small>	<b>197</b>
Circle	<b>197</b>
Jara	<b>197</b>
Nila	<b>197</b>
Street Square	<b>198</b>
Nexus	<b>199</b>
Lavabos bajo-encimera	
Aida	<b>201</b>
Nexus	<b>201</b>
Egeo	<b>201</b>
Flex	<b>201</b>
Lavabos semiempotrar	
Albus <small>galá/IP</small>	<b>203</b>
Circle	<b>203</b>
Jara	<b>203</b>
Lavabos sobremueble	
<sup>N</sup> Luc	<b>205</b>
Mid	<b>206</b>
Klea <small>galá/IP</small>	<b>207</b>

218

MUEBLES DE BAÑO

Shona Modular <small>galá/IP</small>	<b>222</b>
<sup>N</sup> Dane Modular <small>galá/IP</small>	<b>230</b>
Shona <small>galá/IP</small>	<b>238</b>
<sup>N</sup> Dane <small>galá/IP</small>	<b>244</b>
<sup>N</sup> Daily <small>galá/IP</small>	<b>248</b>
<sup>N</sup> Daily + encimera <small>galá/IP</small>	<b>258</b>
Handy <small>galá/IP</small>	<b>274</b>
Mik <small>galá/IP</small>	<b>280</b>
<hr/>	
ESPEJOS Y LUMINARIAS	
Eire	<b>284</b>
Moira	
Iron	
Lya-N	
Addor	
<sup>N</sup> Anne	
Kuadrat	
Tour	
Nero	
Curve	
Only	

ACCESORIOS MUEBLES

296

# Índice

300

## ACCESORIOS

<b>N</b> Morgan	<b>304</b>
Sion	<b>312</b>
<b>N</b> Madoc	<b>320</b>
<b>N</b> Kay Square	<b>330</b>
<b>N</b> Kay Round	<b>342</b>
Avalon	<b>352</b>

358

## URINARIOS

Arq.	<b>361</b>
Argos	<b>361</b>
Minor	<b>362</b>
Easy	<b>362</b>
Separador Urinario	<b>364</b>

## PIEZAS ESPECIALES

Lavadero Burgos-2	<b>364</b>
Vertedero Zinc	<b>364</b>

366

## PLATOS DE DUCHA

Guía rápida	<b>370</b>
-------------	------------

## SURFACE

Base <i>galá/IP</i>	<b>375</b>
<b>N</b> Quantum	<b>378</b>

## PORCELANA

<b>N</b> Gyda	<b>384</b>
---------------	------------

## ACRÍLICOS

<b>N</b> Vita N	<b>390</b>
-----------------	------------

404

## MAMPARAS

Klevan	<b>406</b>
--------	------------

## GALA-DRAIN

Gala-drain L	<b>402</b>
Gala-drain SQ	<b>402</b>

416

## BAÑERAS

Guía rápida	<b>420</b>
-------------	------------

## ACRÍLICAS

Rectangulares	
Mid <i>galá/IP</i>	<b>430</b>
Flex Center <i>galá/IP</i>	<b>434</b>
Emma <i>galá/IP</i>	<b>440</b>
Mitta <i>galá/IP</i>	<b>452</b>
Nila	<b>464</b>

## Angulares

Flex Center <i>galá/IP</i>	<b>468</b>
Trevo <i>galá/IP</i>	<b>474</b>

## Circular

Omega <i>galá/IP</i>	<b>480</b>
----------------------	------------

## ACERO

Ópera <i>galá/IP</i>	<b>484</b>
Vanesa	<b>492</b>
Fedra	<b>496</b>
Gala	<b>500</b>

504

## CONDICIONES GENERALES

506

## DESCATALOGADOS

colección  
**Shower toilet**





# Funcionalidad, diseño y tecnología accesible



**+ intuitivo**



**+ confort**



**+ higiene**



# Shower toilet

## galaVIP



72000 **INODORO BTW RIMLESS** €65 4 €2.150,0  
 68,5 x 38,5 cm  
 Con salida dual, codo de evacuación y juego de anclaje. Tanque bajo con tapa y mecanismo de doble pulsador 4,5/3 litros. Asiento con E-Bidet. Accesorios de instalación incluidos.



72010 **INODORO SUSPENDIDO RIMLESS** €35 4 €2.075,0  
 56 x 38,5 cm  
 Salida horizontal. Asiento con E-bidet. Accesorios de instalación incluidos.

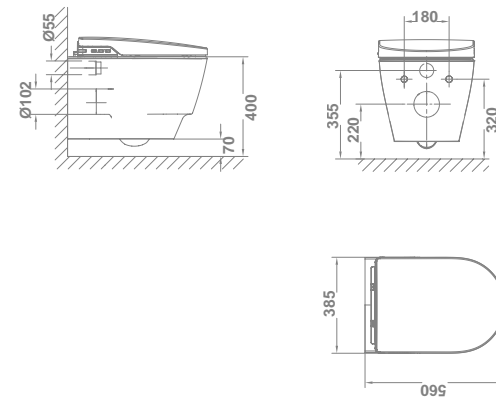
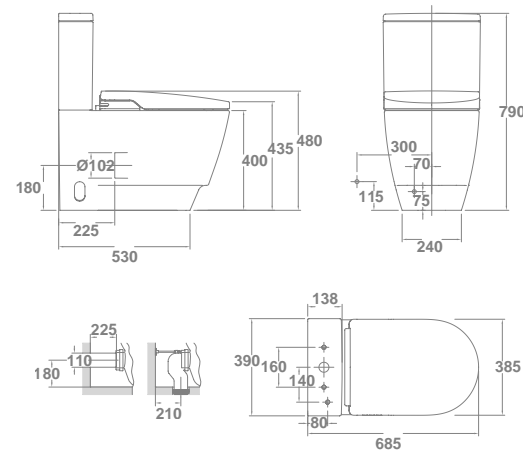

**WC FULL FRAME GALA INNOVA**  
55484



**PULSADOR DOBLE DESCARGA EON 3**  
5056369



**CONJUNTO COMPLETO**  
El conjunto completo está formado por: inodoro suspendido, WC Full Frame Gala Innova y pulsador de doble descarga Eon 3 Cromo Brillo.

€/u  
2.491,5

**colecciones**





# Colecciones

índice

022

NOBLE

028

EOS

036

CORAL

044

EMMA SQUARE

058

EMMA 

074

MID

084

SMART

094

STREET SQUARE

104

ARIS 

114

ELIA

124

LIZZ 

134

BABY WC

138

BLUE

142

ASIENTOS

# Guía Rápida

## Tanque bajo BTW



**Eos**  
60x34 cm  
p.32

**Coral**  
62x36 cm  
p.40

**Emma Square**  
61,5x36 cm  
p.52

**Emma**  
60x36 cm  
p.60 - 62

**Mid**  
60x36 cm  
p.78

**Smart**  
61,5x35 cm  
p.88

**Street Square**  
60x35 cm  
p.98

## Tanque bajo



**Noble**  
68x36 cm  
p.26

**Smart**  
65x35 cm  
p.88

**Street Square**  
64x35 cm  
p.98

**Aris**  
66x36 cm  
p.108

**Elia**  
66x35 cm  
p.118

**Lizz**  
67x35,5 cm  
p.128

**Blue**  
71,5x36 cm  
p.140

## Tanque alto



**Emma Square**  
54x36 cm  
p.51

**Emma**  
54x36 cm  
p.64

**Smart**  
55x35 cm  
p.87

**Aris**  
54x36 cm  
p.108

**Elia**  
47x35 cm  
p.117

**Lizz**  
53x35,5 cm  
p.127

**Baby WC**  
41,5x26,5 cm  
p.130

## Suspendidos

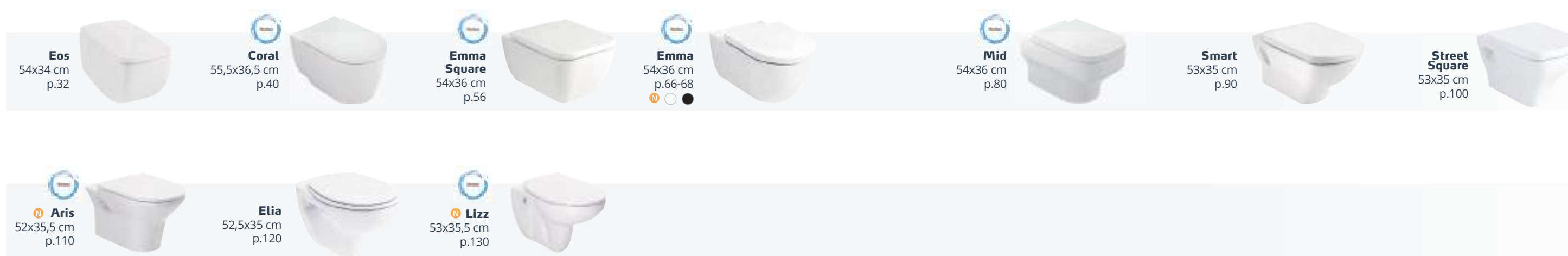

**Eos**  
54x34 cm  
p.32

**Coral**  
55,5x36,5 cm  
p.40

**Emma Square**  
54x36 cm  
p.56

**Emma**  
54x36 cm  
p.66-68

**Mid**  
54x36 cm  
p.80

**Smart**  
53x35 cm  
p.90

**Street Square**  
53x35 cm  
p.100

**Aris**  
52x35,5 cm  
p.110

**Elia**  
52,5x35 cm  
p.120

**Lizz**  
53x35,5 cm  
p.130

# Guía Rápida

## Tanque bajo BTW



## Tanque bajo



## Tanque alto



## Suspendidos

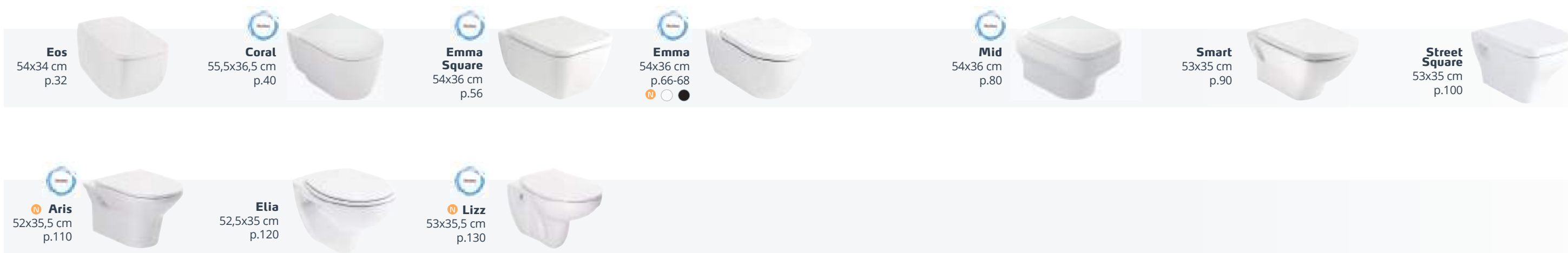



col.  
**Noble**





# Noble

galaVIP



€/u

12040 **LAVABO**   227,6  
60 x 50 cm  
Con rebosadero y juego de fijación.  
Posibilidad de instalación  
con pedestal o mural.

12430 **PEDESTAL**   141,1

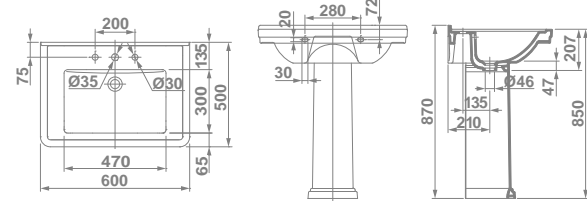

# Noble

galaVIP



€/u

12120 **INODORO** 68 x 36 cm   368,7

Con salida dual y juego de anclaje. Para instalación con salida vertical es necesario codo. *Ver ref. en repuestos.* Para instalación con salida horizontal no es necesario codo.

12540 **TANQUE BAJO CON TAPA** y mecanismo de doble pulsador Alimentación inferior izquierda.   299,7

5161001 **ASIENTO DE MADERA FIJO** Blanco. 135,4

5161101 **ASIENTO DE MADERA CON CAÍDA AMORTIGUADA** Blanco. 205,0



5161085 **ASIENTO DE MADERA FIJO** Nogal. 135,4

5161185 **ASIENTO DE MADERA CON CAÍDA AMORTIGUADA** Nogal. 205,0

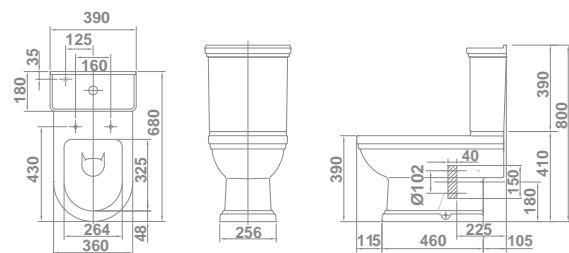
**CONJUNTO INODORO COMPLETO** 803,8



€/u

12360 **BIDÉ** 58 x 36 cm   314,2

con juego de anclaje.

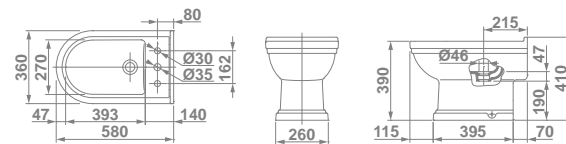

## + REPUESTOS Y ACCESORIOS

€/u

12630	Tapa tanque	52,3	53280	Juego de fijación lavabo	5,6
50711	Mecanismo de doble pulsador completo 2018	101,9	53720	Codo curvo para inodoro tanque bajo salida vertical (para adaptar a distancia a pared de 210 mm). Varilla no necesaria y no incluida.	17,2
50721	Conjunto doble pulsador varillas roscadas 2018	17,9	53690	Juego de unión tanque-inodoro	5,1
55375	Juego de fijación asiento fijo	30,5	53294	Juego de anclaje inodoro y bidé	5,4
55376	Juego de fijación asiento amortiguado	100,0			
55378	Topes asiento noble (bolsa de 6 uds)	7,0			

**Nota:** El conjunto inodoro completo está formado por: inodoro para tanque bajo, tanque completo y asiento de madera fijo blanco. Todas las piezas se suministran en caja.



col.  
**E o s**

# Eos galaVIP



	€/u
34260 <b>INODORO PARA TANQUE BAJO BTW RIMLESS</b> 60 x 34 cm Con salida dual y juego de anclaje a pared. Para instalación con salida vertical es necesario codo. <i>Ver ref. en repuestos.</i> Para instalación con salida horizontal no es necesario codo.	350,2
34540 <b>TANQUE BAJO CON TAPA</b> y mecanismo de doble pulsador. Alimentación inferior izquierda oculta.	273,0
51318 <b>ASIENTO FIJO</b>	97,5
51319 <b>ASIENTO CON CAÍDA AMORTIGUADA</b>	152,4

	€/u
34160 <b>INODORO PARA TANQUE BAJO BTW</b> 60 x 34 cm Con salida dual y juego de anclaje. Para instalación con salida vertical es necesario codo. <i>Ver ref. en repuestos.</i> Para instalación con salida horizontal no es necesario codo.	323,4
34540 <b>TANQUE BAJO CON TAPA</b> y mecanismo de doble pulsador. Alimentación inferior izquierda oculta.	273,0
51318 <b>ASIENTO FIJO</b>	97,5
51319 <b>ASIENTO CON CAÍDA AMORTIGUADA</b>	152,4

**CONJUNTO INODORO COMPLETO\*** 720,7

**CONJUNTO INODORO COMPLETO\*\*** 693,9

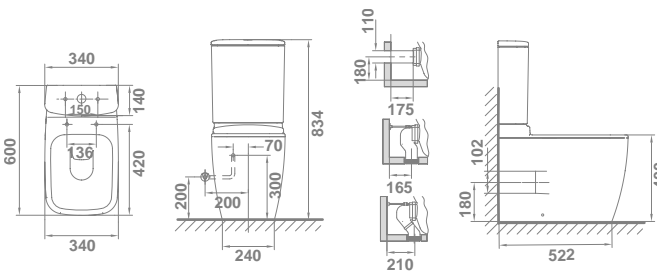

	€/u
34360 <b>BIDÉ BTW</b> 54 x 34 cm Con juego de anclaje.	249,3
51316 <b>TAPA PARA BIDÉ</b>	86,5
51317 <b>TAPA PARA BIDÉ CON CAÍDA AMORTIGUADA</b>	133,7

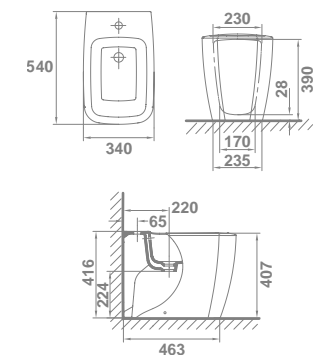

**Nota:** \*El conjunto inodoro completo está formado por: inodoro para tanque bajo BTW rimless, tanque completo y asiento fijo.  
\*\*El conjunto inodoro completo está formado por: inodoro para tanque bajo BTW, tanque completo y asiento fijo.  
BTW: Pegado a la pared. Todas las piezas se suministran en caja.

# Eos suspendida galaVIP



	€/u
34172 <b>INODORO SUSPENDIDO</b> 54 x 34 cm Salida horizontal. Fijación oculta incluida.	372,9
51318 <b>ASIENTO FIJO</b>	97,5
51319 <b>ASIENTO CON CAÍDA AMORTIGUADA</b>	152,4
<b>CONJUNTO INODORO COMPLETO*</b>	<b>470,4</b>

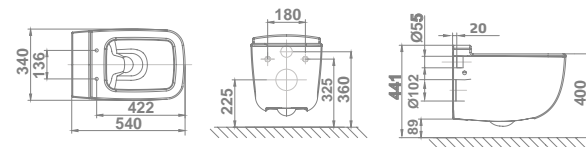

	€/u
55483 <b>WC FULL FRAME EON</b> Sistema de instalación para inodoro suspendido en pared ligera. Descarga de 6/3L, 4,5/3L y 4/2L. Accesorios de instalación incluidos. Profundidad mínima: 108/125 mm (DN90/DN100). Codo ø90 o 110 mm	244,0
5056369 <b>PULSADOR DE DOBLE DESCARGA EON 3</b> Cromo brillo.	48,5
<b>CONJUNTO COMPLETO**</b>	<b>762,9</b>

Otras posibilidades de instalación en páginas 148 - 161.



	€/u
34362 <b>BIDÉ SUSPENDIDO</b> 54 x 34 cm Fijación oculta incluida.	340,4
51316 <b>TAPA PARA BIDÉ</b>	86,5
51317 <b>TAPA PARA BIDÉ CON CAÍDA AMORTIGUADA</b>	133,7

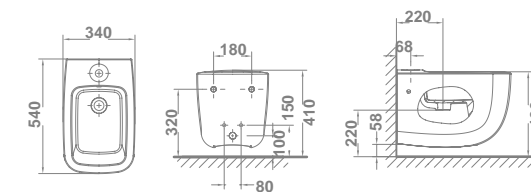

	€/u
55409 <b>BIDÉ FRAME EON COMPACT</b> Soporte para bidé. Accesorios de instalación incluidos. Profundidad mínima de 8 cm	244,0

**Nota:** \*El conjunto inodoro completo está formado por: inodoro suspendido y asiento fijo. Todas las piezas se suministran en caja. \*\*El conjunto completo está formado por: inodoro suspendido, asiento fijo, WC Full Frame Eon y pulsador de doble descarga Eon 3 Cromo Brillo.

## Eos

+ REPUESTOS Y ACCESORIOS		€/u
34630	Tapa tanque Eos	36,1
50710	Mecanismo de doble pulsador completo 4,5/3 litros 2018	101,9
50416	Mecanismo de alimentación	28,7
50720	Mecanismo de descarga 4,5/3 litros 2018	54,8
50721	Conjunto doble pulsador varillas roscadas 2018	17,9
53692	Juego de unión tanque-inodoro	6,1
53629	Juego de fijación oculto para inodoro y bidé suspendidos	35,0
53828	Conjunto bisagra completa asiento fijo Eos (bisagra y juego de fijación)	35,7
53827	Conjunto bisagra completa asiento amortiguado Eos (bisagra y juego de fijación)	71,0
53830	Juego de fijación asiento fijo y caída amortiguada Eos	6,8
53832	Conjunto bisagra completa tapa bidé fija Eos (bisagra y juego de fijación)	21,4
53833	Conjunto bisagra completa tapa bidé amortiguada Eos (bisagra y juego de fijación)	40,6
53831	Juego de fijación tapa bidé Eos	6,8
54269	Topes asientos Eos (bolsa de 6 unidades)	6,0
54269	Topes tapa bidé Eos (bolsa de 6 unidades)	6,0
50463	Codo curvo para inodoro tanque bajo salida vertical (para adaptar a distancia a pared de 210 mm). Recomendada instalación con varilla. Varilla no incluida.	27,2
53720	Codo curvo para inodoro tanque bajo salida vertical (para adaptar a distancia a pared de 165 mm). Recomendada instalación con varilla. Varilla no incluida.	17,2
50464	Varilla fijación codo curvo	2,1
53294	Juego de anclaje inodoro y bidé	5,4





col.  
**Coral**

# Coral galaVIP



		€/u
09160	<b>INODORO PARA TANQUE BAJO BTW</b> 62 x 36 cm Con salida dual y juego de anclaje. Para instalación con salida vertical es necesario codo. Para instalación con salida horizontal no es necesario codo. <i>Ver ref. en repuestos.</i>	278,0
09540	<b>TANQUE BAJO CON TAPA</b> y mecanismo de doble pulsador. Alimentación inferior izquierda.	258,5
51695	<b>ASIENTO FIJO SLIM ENVOLVENTE</b>	84,5
51696	<b>ASIENTO CON CAÍDA AMORTIGUADA SLIM ENVOLVENTE</b>	146,5
	<b>CONJUNTO INODORO COMPLETO**</b>	<b>621,0</b>

		€/u
09360	<b>BIDÉ BTW</b> 54 x 36 cm Con juego de anclaje.	222,5

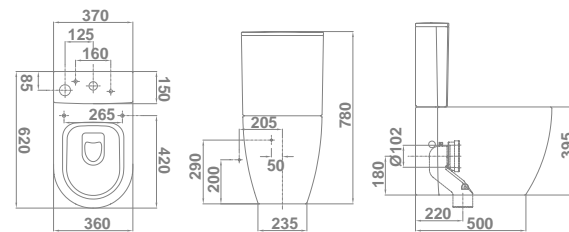
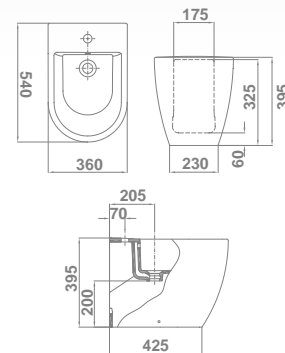

**Nota:** \*El conjunto inodoro completo está formado por: inodoro para tanque alto BTW y asiento fijo. \*\*El conjunto inodoro completo está formado por: inodoro para tanque bajo BTW, tanque completo y asiento fijo.  
BTW: Pegado a la pared. Todas las piezas se suministran en caja.



# Coral suspendida galaVIP



		€/u
09172	<b>INODORO SUSPENDIDO RIMLESS</b> 55,5 x 36,5 cm Salida horizontal.	330,0
51695	<b>ASIENTO FIJO SLIM ENVOLVENTE</b>	84,5
51696	<b>ASIENTO CON CAÍDA AMORTIGUADA SLIM ENVOLVENTE</b>	146,5
<b>CONJUNTO INODORO COMPLETO*</b>		<b>414,5</b>

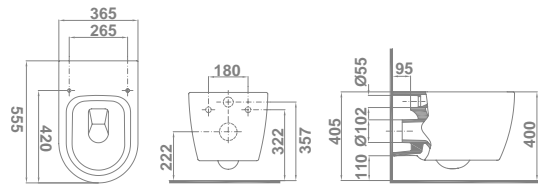

		€/u
55483	<b>WC FULL FRAME EON</b> Sistema de instalación para inodoro suspendido en pared ligera. Descarga de 6/3L, 4,5/3L y 4/2L. Accesorios de instalación incluidos. Profundidad mínima: 108/125 mm (DN90/DN100). Codo Ø90 o 110 mm	244,0
5056369	<b>PULSADOR DE DOBLE DESCARGA EON 3</b> Cromo brillo.	48,5

**CONJUNTO COMPLETO\*\* 707,0**

Otras posibilidades de instalación en páginas 148 - 161.



		€/u
09362	<b>BIDÉ SUSPENDIDO</b> 55,5 x 36 cm Con juego de anclaje.	296,0

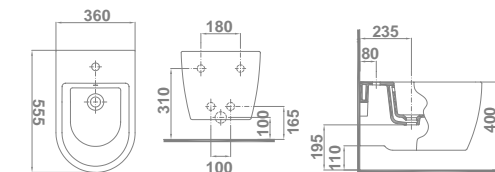

		€/u
55409	<b>BIDÉ FRAME EON COMPACT</b> Soporte para bidé. Accesorios de instalación incluidos. Profundidad mínima de 8 cm	244,0

**Nota:** \*El conjunto inodoro completo está formado por: inodoro suspendido rimless y asiento fijo.  
\*\*El conjunto completo está formado por: inodoro suspendido, asiento fijo, WC Full Frame Eon y pulsador de doble descarga Eon 3 Cromo Brillo.

# Coral

## + REPUESTOS Y ACCESORIOS

	€/u
09630 Tapa tanque Coral	33,0
50491 Mecanismo de alimentación	20,0
50355 Mecanismo de descarga 4,5/3 litros	34,9
50520 Conjunto doble pulsador de varillas roscadas	13,4
53690 Juego de unión tanque-inodoro	5,1
53298 Juego de fijación oculto para inodoro y bidé suspendidos	37,5
53817 Conjunto bisagra completa asiento caída amortiguada Coral	61,3
53720 Codo curvo para inodoro tanque alto salida vertical (para adaptar a distancia a pared de 90 mm). Recomendada instalación con varilla. Varilla no incluida.	17,2
50463 Codo curvo para inodoro tanque bajo salida vertical (para adaptar a distancia a pared de 220 mm). Recomendada instalación con varilla. Varilla no incluida.	27,2
50464 Varilla fijación codo curvo	2,1
53294 Juego de anclaje inodoro y bidé	5,4





col.

# Emma Square

# Emma Square galaVIP

colecciones



			€/u	
<b>LAVABO COMPACT</b>				
Con rebosadero y juego de fijación. Posibilidad de instalación con pedestal, semipedestal, mural o sobre-encimera.				
27015	<b>60x35 cm</b>			121,5
27005	<b>55x35 cm</b>			119,5
27080	<b>50x35 cm</b>			113,0

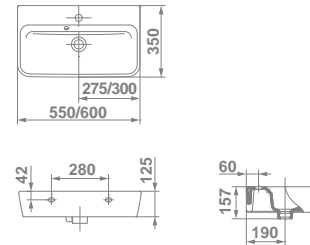

			€/u	
<b>LAVAMANOS 50X25 CM</b>				
Con rebosadero y juego de fijación. Posibilidad de instalación mural o sobre-encimera.				
27095				108,0

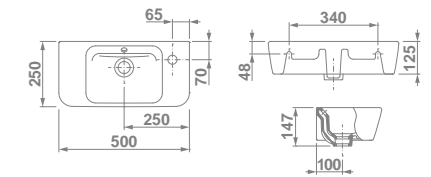

			€/u	
<b>LAVAMANOS 42X32 CM</b>				
Con rebosadero y juego de fijación. Posibilidad de instalación mural o sobre-encimera.				
27085				109,0

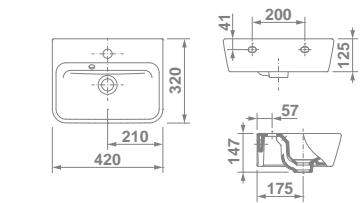

			€/u	
<b>LAVABO</b>				
Con rebosadero y juego de fijación. Posibilidad de instalación con pedestal, semipedestal, mural o sobre-encimera.				
27020	<b>65x45 cm</b>			137,5
27010	<b>60x45 cm</b>			123,5
27000	<b>55x45 cm</b>			120,5

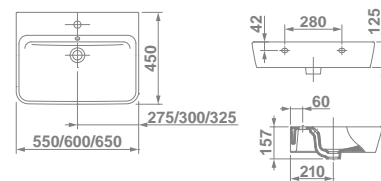

			€/u	
<b>LAVAMANOS 48X37,5 CM</b>				
Con pedestal integrado, rebosadero y juego de fijación. Instalación mural.				
27075				163,0

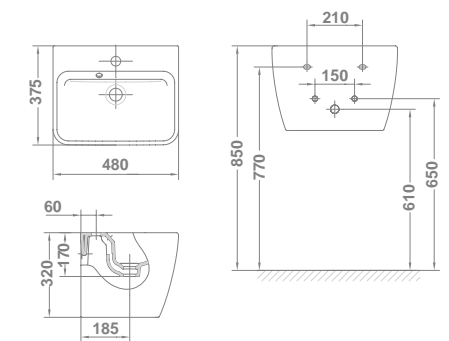

			€/u	
<b>LAVABO DE ENCIMERA</b>				
Con rebosadero.				
27060	<b>55x42 cm</b>			169,0

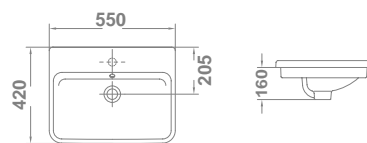

Nota: Los lavabos Emma Square se suministran con embellecedor para rebosadero. Todas las piezas se suministran en caja.

# Emma Square galaVIP

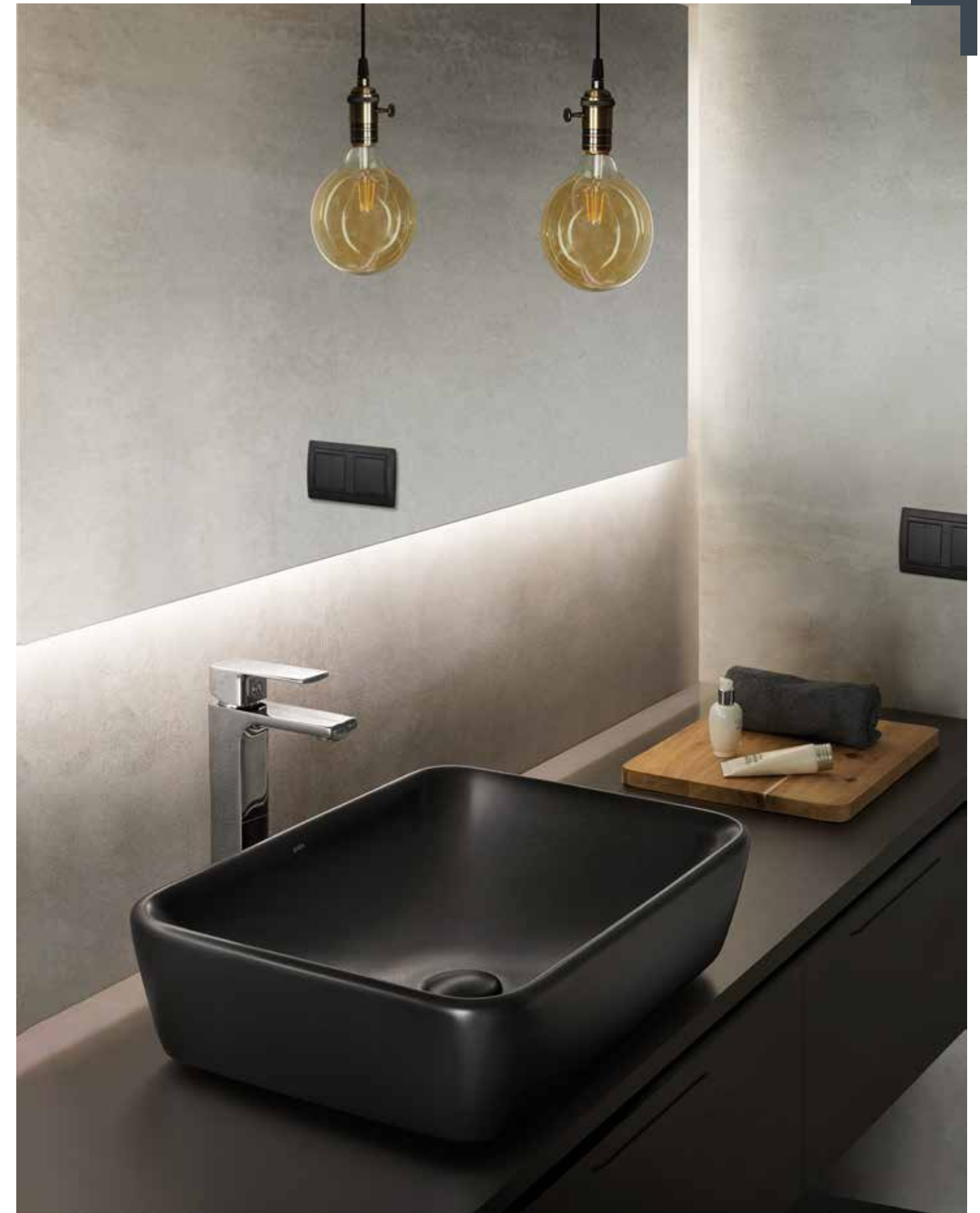

27050 **LAVABO 50X38 CM** €/u  
 De sobre-encimera.  
 Sin rebosadero. Sin orificio de grifería.



9,9 32 224,0

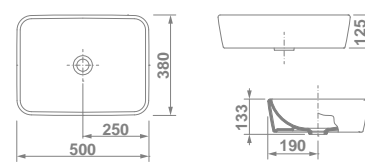

**OPCIONES COLOR**



08 **NEGRO** 256,0



21 **BLANCO MATE** 256,0



**Nota:** Los lavabos Emma Square se suministran con embellecedor para rebosadero. Todas las piezas se suministran en caja.

# Emma Square galaVIP









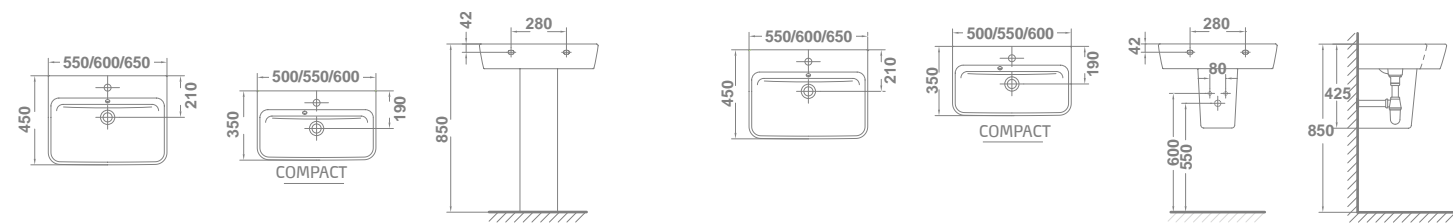





27430 **PEDESTAL**   €/u **88,5**



27432 **SEMIPEDESTAL**   €/u **79,0**  
Con juego de fijación.



**LAVABOS COMBINABLES CON PEDESTAL Y SEMIPEDESTAL**

LAVABOS COMPACT			LAVABOS		
27015	<b>60X35 CM</b>	  121,5	27020	<b>65X45 CM</b>	  137,5
27005	<b>55X35 CM</b>	  119,5	27010	<b>60X45 CM</b>	  123,5
27080	<b>50X35 CM</b>	  113,0	27000	<b>55X45 CM</b>	  120,5



27110	<b>INODORO PARA TANQUE ALTO BTW</b>	  €/u <b>284,0</b>
51648	<b>ASIENTO FIJO SLIM</b>	<b>73,0</b>
51649	<b>ASIENTO CON CAIDA AMORTIGUADA SLIM</b>	<b>130,0</b>
51640	<b>ASIENTO FIJO</b>	<b>73,0</b>
51641	<b>ASIENTO CON CAIDA AMORTIGUADA</b>	<b>130,0</b>
<b>CONJUNTO INODORO COMPLETO*</b>		<b>357,0</b>

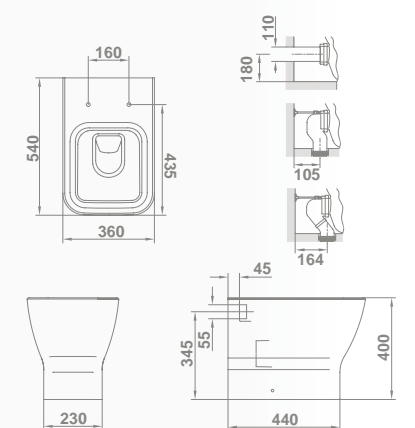

**Nota:** Los lavabos Emma Square se suministran con embellecedor para rebosadero. Todas las piezas se suministran en caja.

**Nota:** \*El conjunto inodoro completo está formado por: inodoro para tanque alto BTW y asiento fijo. BTW: Pegado a la pared. Todas las piezas se suministran en caja.

# Emma Square galaVIP



€/u

- 27260 **INODORO PARA TANQUE BAJO BTW RIMLESS** **325,0**  
60 x 34 cm  
Con salida dual y juego de anclaje. Para instalación con salida vertical es necesario codo. Para instalación con salida horizontal no es necesario codo.
- 27560 **TANQUE BAJO CON TAPA** **171,0**  
   
y mecanismo de doble pulsador. Alimentación inferior izquierda.
- 51648 **ASIENTO FIJO SLIM** **73,0**
- 51649 **ASIENTO CON CAÍDA AMORTIGUADA SLIM** **130,0**
- 51640 **ASIENTO FIJO** **73,0**
- 51641 **ASIENTO CON CAÍDA AMORTIGUADA** **130,0**

**CONJUNTO INODORO COMPLETO\* 569,0**



€/u

- 27160 **INODORO PARA TANQUE BAJO BTW** **274,0**  
61,5 x 36 cm  
Con salida dual y juego de anclaje. Para instalación con salida vertical es necesario codo. Para instalación con salida horizontal no es necesario codo. Ver ref. en respuestas.
- 27558 **TANQUE BAJO CON TAPA** **153,0**  
   
y mecanismo de doble pulsador. Alimentación inferior izquierda.
- 51648 **ASIENTO FIJO SLIM** **73,0**
- 51649 **ASIENTO CON CAÍDA AMORTIGUADA SLIM** **130,0**
- 51640 **ASIENTO FIJO** **73,0**
- 51641 **ASIENTO CON CAÍDA AMORTIGUADA** **130,0**

**CONJUNTO INODORO COMPLETO\*\* 500,0**



€/u

- 27360 **BIDÉ BTW** **183,0**  
54 x 36 cm  
Con juego de anclaje.
- 51650 **TAPA PARA BIDÉ** **75,0**

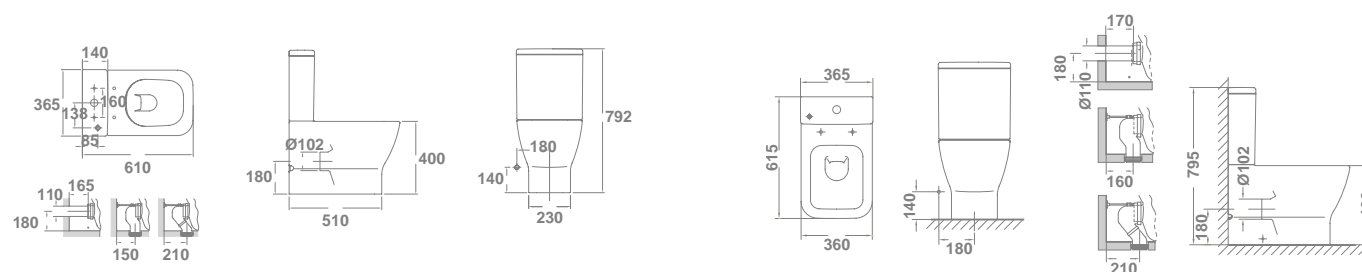
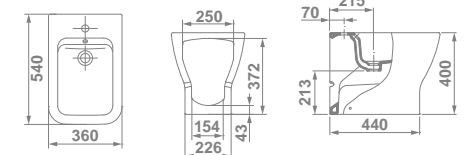

**Nota:** \*El conjunto inodoro completo está formado por: inodoro para tanque bajo BTW rimless, tanque completo 4/2 litros y asiento fijo. \*\*El conjunto inodoro completo está formado por: inodoro para tanque bajo BTW, tanque completo 4,5/3 litros y asiento fijo. BTW: Pegado a la pared. Todas las piezas se suministran en caja.

# Emma Square suspendida

galaVIP



		€/u
27272	<b>INODORO SUSPENDIDO RIMLESS</b> 54 x 36 cm Salida horizontal. Fijación oculta incluida.	326,0
51648	<b>ASIENTO FIJO SLIM</b>	73,0
51649	<b>ASIENTO CON CAÍDA AMORTIGUADA SLIM</b>	130,0
51640	<b>ASIENTO FIJO</b>	73,0
51641	<b>ASIENTO CON CAÍDA AMORTIGUADA</b>	130,0
<b>CONJUNTO INODORO COMPLETO*</b>		<b>399,0</b>

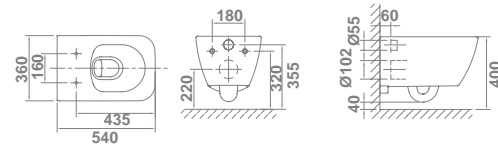

		€/u
55483	<b>WC FULL FRAME EON</b> Sistema de instalación para inodoro suspendido en pared ligera. Descarga de 6/3L, 4,5/3L y 4/2L. Accesorios de instalación incluidos. Profundidad mínima: 108/125 mm (DN90/DN100). Codo ø90 o 110 mm	244,0
5056369	<b>PULSADOR DE DOBLE DESCARGA EON 3</b> Cromo brillo.	48,5
<b>CONJUNTO COMPLETO**</b>		<b>691,5</b>

Otras posibilidades de instalación en páginas 148 - 161.





# Emma Square suspendida

galaVIP



		€/u
27172	<b>INODORO SUSPENDIDO</b> 54 x 36 cm Salida horizontal. Fijación oculta incluida.	293,0
51648	<b>ASIENTO FIJO SLIM</b>	73,0
51649	<b>ASIENTO CON CAÍDA AMORTIGUADA SLIM</b>	130,0
51640	<b>ASIENTO FIJO</b>	73,0
51641	<b>ASIENTO CON CAÍDA AMORTIGUADA</b>	130,0
<b>CONJUNTO INODORO COMPLETO*</b>		<b>366,0</b>

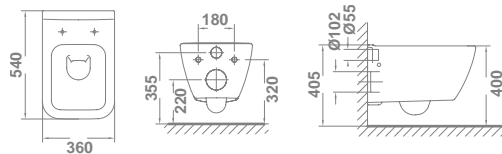

		€/u
55483	<b>WC FULL FRAME EON</b> Sistema de instalación para inodoro suspendido en pared ligera. Descarga de 6/3L, 4,5/3L y 4/2L. Accesorios de instalación incluidos. Profundidad mínima: 108/125 mm (DN90/DN100). Codo ø90 o 110 mm	244,0
5056369	<b>PULSADOR DE DOBLE DESCARGA EON 3</b> Cromo brillo.	48,5

**CONJUNTO COMPLETO\*\*** 658.5

Otras posibilidades de instalación en páginas 148 - 161.



		€/u
27362	<b>BIDÉ SUSPENDIDO</b> 54 x 34 cm Fijación oculta incluida.	239,0
51650	<b>TAPA PARA BIDÉ</b>	75,0

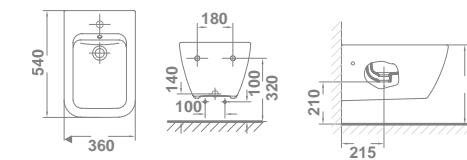

		€/u
55409	<b>BIDÉ FRAME EON COMPACT</b> Soporte para bidé. Accesorios de instalación incluidos. Profundidad mínima de 8 cm	244,0

**Nota:** \*El conjunto inodoro completo está formado por: inodoro suspendido y asiento fijo. Todas las piezas se suministran en caja. \*\*El conjunto completo está formado por: inodoro suspendido, asiento fijo, WC Full Frame Eon y pulsador de doble descarga Eon 3 Cromo Brillo.



col.  
**E m m a**

Disponibilidad 2º semestre de 2024



Acabado negro

€/u

**3026008 INODORO PARA TANQUE BAJO BTW RIMLESS NEGRO** 30 24 **325,0**

60 x 36 cm  
Con salida dual y juego de anclaje. Para instalación con salida vertical es necesario codo. Para instalación con salida horizontal no es necesario codo. Ver ref. en respuestos.

**2756008 TANQUE BAJO CON TAPA** 14,9 24 **184,0**  
4L 2L  
y mecanismo de doble pulsador. Alimentación inferior izquierda. Negro

**5166108 ASIENTO CON CAÍDA AMORTIGUADA** **127,0**  
Negro.

**CONJUNTO INODORO COMPLETO\* 636,0**

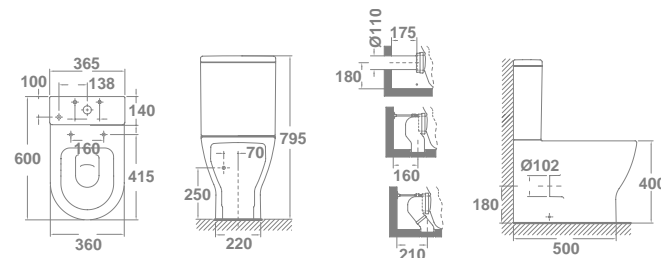

Acabado blanco mate

€/u

**3026021 INODORO PARA TANQUE BAJO BTW RIMLESS BLANCO MATE** 30 24 **325,0**

60 x 36 cm  
Con salida dual y juego de anclaje. Para instalación con salida vertical es necesario codo. Para instalación con salida horizontal no es necesario codo. Ver ref. en respuestos.

**2756021 TANQUE BAJO CON TAPA** 14,9 24 **184,0**  
4L 2L  
y mecanismo de doble pulsador. Alimentación inferior izquierda. Blanco mate.

**5166121 ASIENTO CON CAÍDA AMORTIGUADA** **127,0**  
Blanco mate.

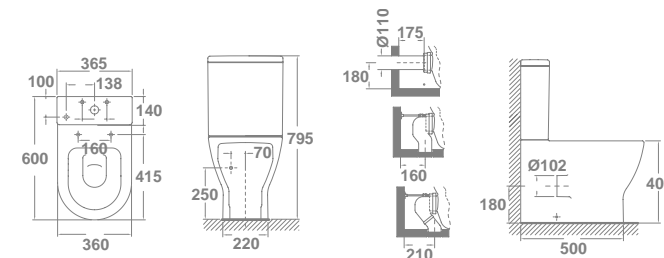

**CONJUNTO INODORO COMPLETO\* 636,0**



**Nota:** \*El conjunto inodoro completo está formado por: inodoro para tanque bajo BTW rimless, tanque completo de 4/2 litros y asiento amortiguado. BTW: Pegado a la pared. El tanque Emma se suministra en caja.

# Emma galaVIP



	€/u
30260 <b>INODORO PARA TANQUE BAJO BTW RIMLESS</b>   60 x 36 cm Con salida dual y juego de anclaje. Para instalación con salida vertical es necesario codo. Para instalación con salida horizontal no es necesario codo. Ver ref. en respuestos.	271,0
27560 <b>TANQUE BAJO CON TAPA</b>   y mecanismo de doble pulsador. Alimentación inferior izquierda.	171,0
51664 <b>ASIENTO FIJO SLIM</b>	68,5
51665 <b>ASIENTO CON CAÍDA AMORTIGUADA SLIM</b>	106,0
51660 <b>ASIENTO FIJO</b>	68,5
51661 <b>ASIENTO CON CAÍDA AMORTIGUADA</b>	106,0
<b>CONJUNTO INODORO COMPLETO*</b>	<b>510,5</b>

	€/u
30160 <b>INODORO PARA TANQUE BAJO BTW COMPACT</b>   60 x 36 cm Con salida dual y juego de anclaje. Para instalación con salida vertical es necesario codo. Para instalación con salida horizontal no es necesario codo. Ver ref. en respuestos.	227,0
27558 <b>TANQUE BAJO CON TAPA</b>   y mecanismo de doble pulsador. Alimentación inferior izquierda.	153,0
51664 <b>ASIENTO FIJO SLIM</b>	68,5
51665 <b>ASIENTO CON CAÍDA AMORTIGUADA SLIM</b>	106,0
51660 <b>ASIENTO FIJO</b>	68,5
51661 <b>ASIENTO CON CAÍDA AMORTIGUADA</b>	106,0
<b>CONJUNTO INODORO COMPLETO**</b>	<b>498,5</b>

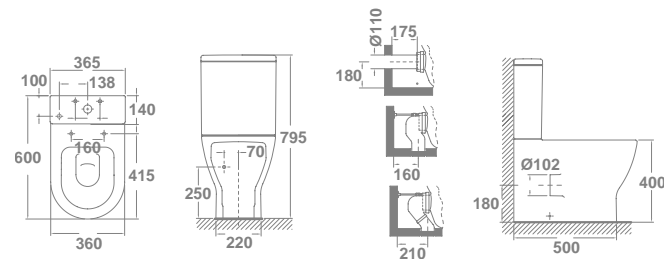
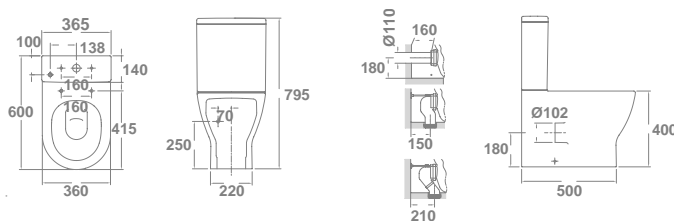

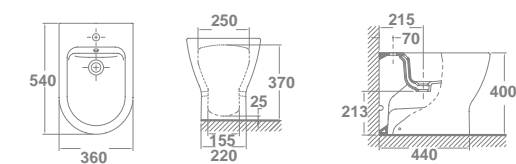

	€/u
30360 <b>BIDÉ BTW</b>   54 x 36 cm Con juego de anclaje.	149,5
51670 <b>TAPA PARA BIDÉ</b>	68,0



Nota: \*El conjunto inodoro completo está formado por: inodoro para tanque bajo BTW rimless, tanque completo de 4/2 litros y asiento fijo. BTW: Pegado a la pared. El tanque Emma se suministra en caja. \*\* El conjunto inodoro completo está formado por inodoro para tanque bajo BTW, tanque completo de 4,5/3litros y asiento fijo.



€/u

30140	<b>INODORO PARA TANQUE ALTO BTW</b> 54 x 36 cm Con salida dual y juego de anclaje. Para instalación con salida vertical es necesario codo. Para instalación con salida horizontal no es necesario codo. Ver ref. en respuestas.	 	264,0
51664	<b>ASIENTO FIJO SLIM</b>		68,5
51665	<b>ASIENTO CON CAÍDA AMORTIGUADA SLIM</b>		106,0
51660	<b>ASIENTO FIJO</b>		68,5
51661	<b>ASIENTO CON CAÍDA AMORTIGUADA</b>		106,0
	<b>CONJUNTO INODORO COMPLETO*</b>		<b>332,5</b>

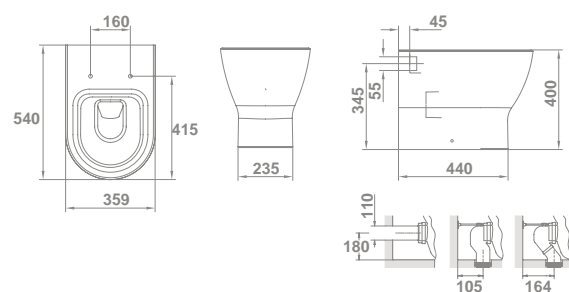

**Nota:** \* El conjunto inodoro completo está formado por: inodoro para tanque alto BTW y asiento fijo. BTW: Pegado a la pared. El tanque Emma se suministra en caja.

# Emma suspendida galaVIP N

Disponibilidad 2º semestre de 2024

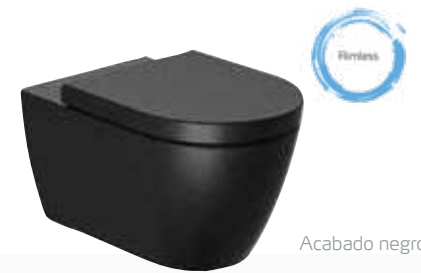

Acabado negro



Acabado blanco mate

	€/u
<b>3027308</b> <small>Novedad</small> <b>INODORO SUSPENDIDO RIMLESS NEGRO</b> 54 x 36 cm Con salida horizontal. Fijación oculta incluida.	316,0
<b>5166108</b> <small>Novedad</small> <b>ASIENTO CON CAÍDA AMORTIGUADA</b> Negro.	127,0
<b>CONJUNTO INODORO COMPLETO*</b>	<b>443.0</b>

	€/u
<b>3027321</b> <small>Novedad</small> <b>INODORO SUSPENDIDO RIMLESS BLANCO MATE</b> 54 x 36 cm Con salida horizontal. Fijación oculta incluida.	316,0
<b>5166121</b> <small>Novedad</small> <b>ASIENTO CON CAÍDA AMORTIGUADA</b> Blanco mate.	127,0
<b>CONJUNTO INODORO COMPLETO*</b>	<b>443.0</b>

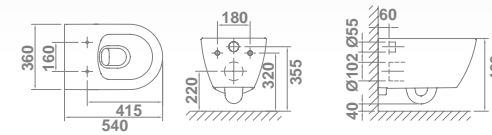
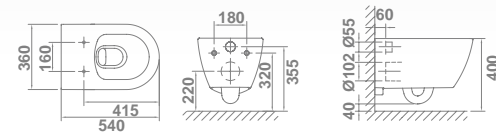

	€/u
<b>55483</b> <b>WC FULL FRAME EON</b> Sistema de instalación para inodoro suspendido en pared ligera. Descarga de 6/3L, 4,5/3L y 4/2L. Accesorios de instalación incluidos. Profundidad mínima: 108/125 mm (DN90/DN100). Codo ø90 o 110 mm	244,0



<b>5056702</b> <b>PULSADOR DE DOBLE DESCARGA EON 11</b> Negro.	48,5
---	------



<b>5056721</b> <b>PULSADOR DE DOBLE DESCARGA EON 11</b> Blanco mate	48,5
--	------

<b>CONJUNTO COMPLETO**</b>	<b>735.5</b>
----------------------------	--------------

Otras posibilidades de instalación en páginas 148 - 161.

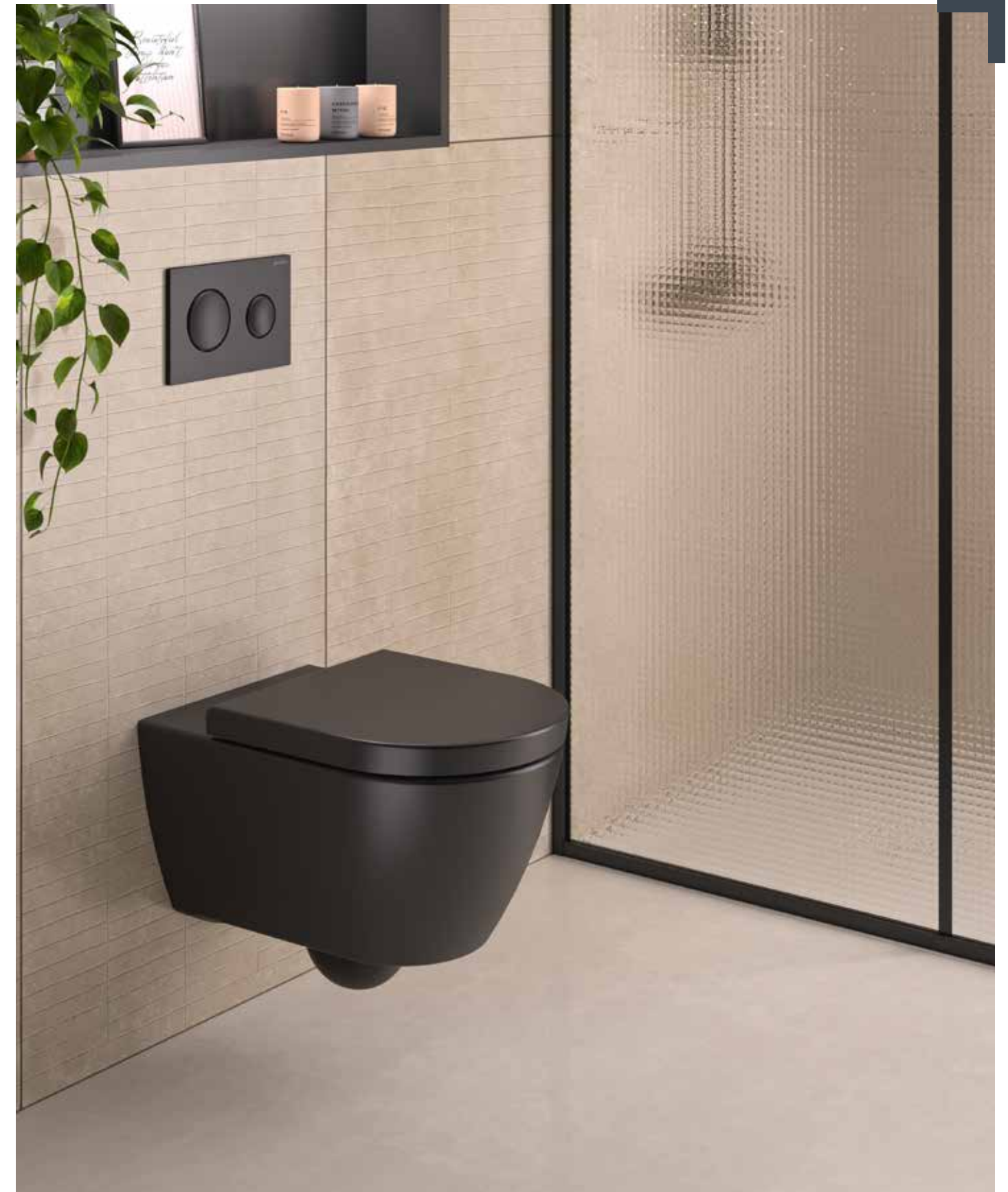

**Nota:** \*El conjunto inodoro completo está formado por: inodoro suspendido rimless y asiento fijo. Todas las piezas se suministran en caja. \*\*El conjunto completo está formado por: inodoro suspendido rimless, asiento fijo, WC Full Frame Eon y pulsador de doble descarga Eon 3 Cromo Brillo.

# Emma suspendida galaVIP



		€/u
30272	<b>INODORO SUSPENDIDO RIMLESS</b> 54 x 36 cm Con salida horizontal. Fijación oculta incluida.	263,0
51664	<b>ASIENTO FIJO SLIM</b>	68,5
51665	<b>ASIENTO CON CAÍDA AMORTIGUADA SLIM</b>	106,0
51660	<b>ASIENTO FIJO</b>	68,5
51661	<b>ASIENTO CON CAÍDA AMORTIGUADA</b>	106,0
<b>CONJUNTO INODORO COMPLETO *</b>		<b>331,5</b>

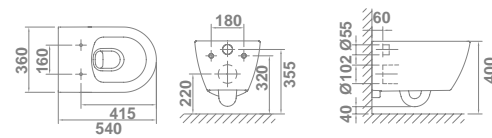

		€/u
55483	<b>WC FULL FRAME EON</b> Sistema de instalación para inodoro suspendido en pared ligera. Descarga de 6/3L, 4,5/3L y 4/2L. Accesorios de instalación incluidos. Profundidad mínima: 108/125 mm (DN90/DN100). Codo ø90 o 110 mm	244,0
5056369	<b>PULSADOR DE DOBLE DESCARGA EON 3</b> Cromo brillo.	48,5
<b>CONJUNTO COMPLETO **</b>		<b>624,0</b>

Otras posibilidades de instalación en páginas 148 - 161.

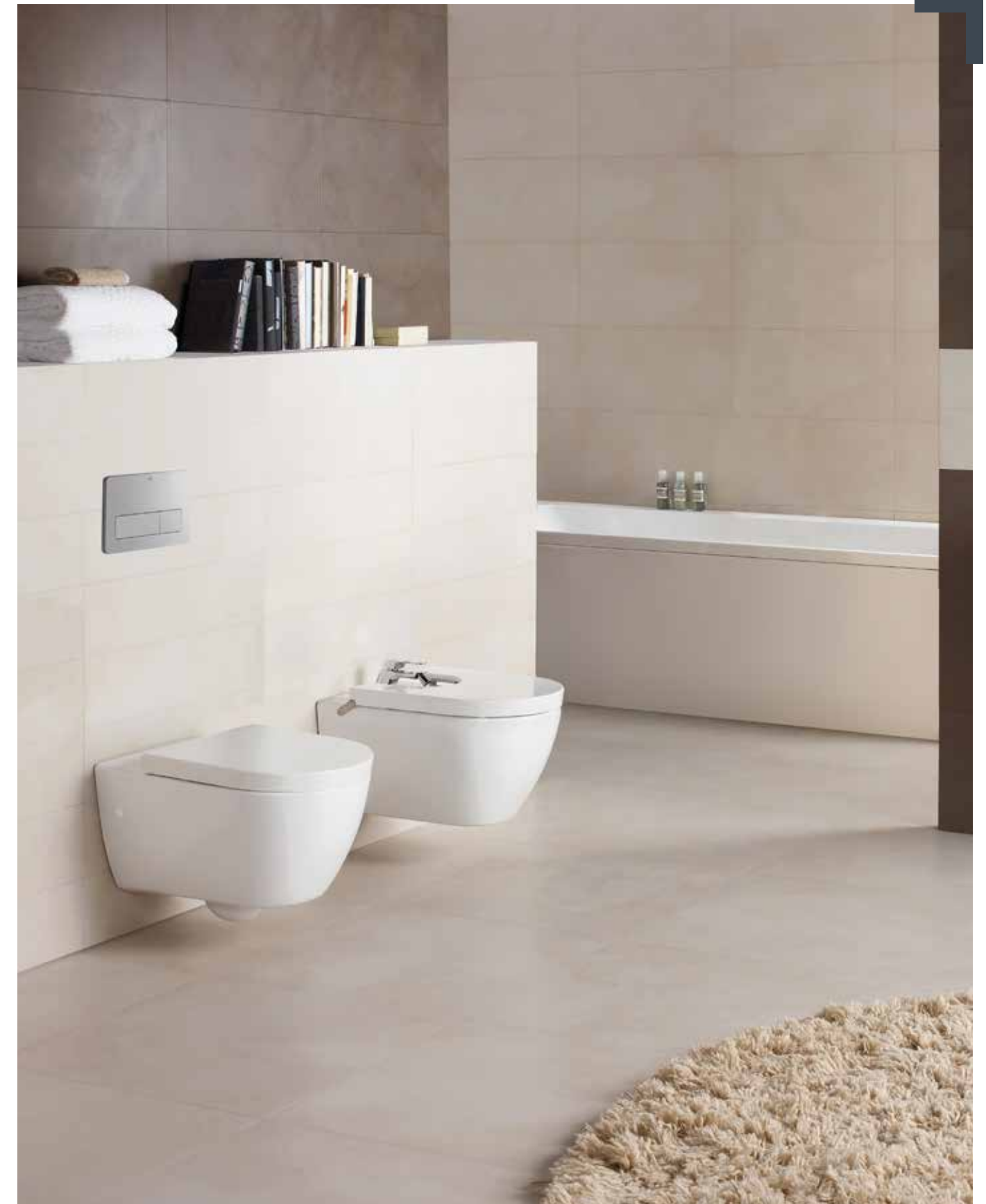

**Nota:** \*El conjunto inodoro completo está formado por: inodoro suspendido rimless y asiento fijo. Todas las piezas se suministran en caja. \*\*El conjunto completo está formado por: inodoro suspendido rimless, asiento fijo, WC Full Frame Eon y pulsador de doble descarga Eon 3 Cromo Brillo.

# Emma suspendida galaVIP



		€/u
30172	<b>INODORO SUSPENDIDO</b> 54 x 36 cm Salida horizontal. Fijación oculta incluida.	240,0
51664	<b>ASIENTO FIJO SLIM</b>	68,5
51665	<b>ASIENTO CON CAÍDA AMORTIGUADA SLIM</b>	106,0
51660	<b>ASIENTO FIJO</b>	68,5
51661	<b>ASIENTO CON CAÍDA AMORTIGUADA</b>	106,0
<b>CONJUNTO INODORO COMPLETO*</b>		<b>308,5</b>

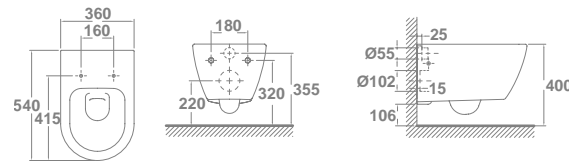

		€/u
55483	<b>WC FULL FRAME EON</b> Sistema de instalación para inodoro suspendido en pared ligera. Descarga de 6/3L, 4,5/3L y 4/2L. Accesorios de instalación incluidos. Profundidad mínima: 108/125 mm (DN90/DN100). Codo ø90 o 110 mm	244,0
5056369	<b>PULSADOR DE DOBLE DESCARGA EON 3</b> Cromo brillo.	48,5
<b>CONJUNTO COMPLETO**</b>		<b>601,0</b>

Otras posibilidades de instalación en páginas 148 - 161.

**Nota:** \*El conjunto inodoro completo está formado por: inodoro suspendido y asiento fijo. Todas las piezas se suministran en caja. \*\*El conjunto completo está formado por: inodoro suspendido, asiento fijo, WC Full Frame Eon y pulsador de doble descarga Eon 3 Cromo Brillo.



		€/u
30362	<b>BIDÉ SUSPENDIDO</b> 54 x 36 cm Fijación oculta incluida.	196,0
51670	<b>TAPA PARA BIDÉ</b>	68,0

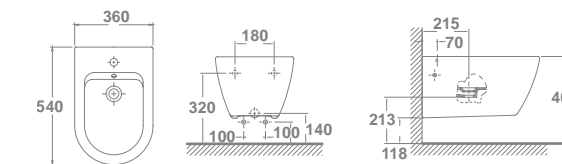

		€/u
55409	<b>BIDÉ FRAME EON COMPACT</b> Soporte para bidé. Accesorios de instalación incluidos. Profundidad mínima de 8 cm	244,0



# Emma Square | Emma

## + REPUESTOS Y ACCESORIOS

		€/u
27630	Tapa tanque Emma   Emma Square.	31,0
50282	Mecanismo de doble pulsador completo 4,5/3 litros.	54,8
50491	Mecanismo de alimentación.	20,0
50355	Mecanismo de descarga 4,5/3 litros.	34,9
50520	Conjunto doble pulsador varillas roscadas.	13,4
50495	Goma cierre descarga.	1,3
53695	Juego de unión tanque-inodoro Emma   Emma Square.	6,1
53629	Juego de fijación oculto para inodoro y bidé suspendidos.	35,0
53296	Juego de fijación oculto para inodoro suspendido rimless.	38,1
53813	Conjunto bisagra completa asiento fijo Emma   Emma Square.	15,3
53811	Conjunto bisagra completa asiento extraíble Emma   Emma Square.	34,2
53812	Conjunto bisagra completa asiento caída amortiguada Emma   Emma Square.	62,7
55296	Conjunto bisagra completa tapa bidé Emma   Emma Square.	22,0
53801	Juego de fijación asiento extraíble y amortiguado.	6,6
54269	Topes asientos Emma Square (bolsa de 6 unidades) Anterior a 2013.	6,0
54269	Topes tapa bidé Emma Square (bolsa de 6 unidades) Anterior a 2013.	6,0
55332	Topes asientos Emma Square (bolsa de 6 unidades).	6,0
55332	Topes tapa bidé Emma Square (bolsa de 6 unidades).	6,0
54292	Topes asientos Emma (bolsa de 6 unidades).	12,5
54292	Topes tapa bidé Emma (bolsa de 6 unidades).	12,5
53280	Juego de fijación lavabo.	5,6
53990	Juego de fijación semipedestal.	10,1
50463	Codo curvo para inodoro tanque bajo salida vertical (para adaptar a distancia a pared de 210 mm). Recomendada instalación con varilla. Varilla no. incluida.	27,2
53720	Codo curvo para inodoro tanque bajo salida vertical (para adaptar a distancia a pared de 160 mm). Recomendada instalación con varilla. Varilla no. incluida.	17,2
50464	Varilla fijación codo curvo.	2,1
53511	Embellecedor para rebosadero lavabos Emma Square.	3,9
53294	Juego de anclaje inodoro y bidé.	5,4

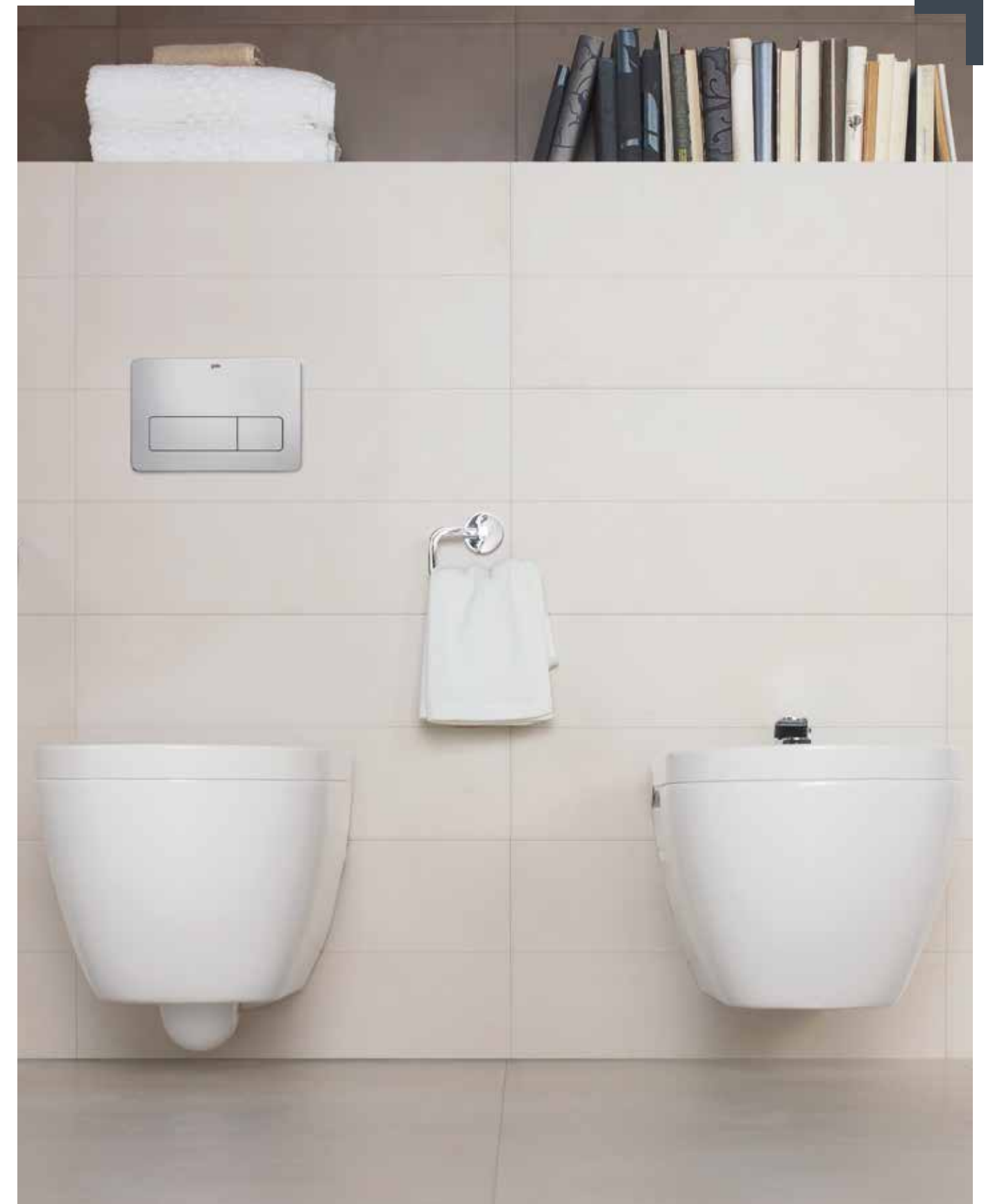



col.  
**Mid**

# Mid



- €/u
- LAVABO**  
Con rebosadero y juego de fijación.  
Posibilidad de instalación con pedestal\*, semipedestal\* o mural.
- 40020 **65x45 cm** 126,0
  - 40030 **60x45 cm** 114,5
  - 40040 **55x45 cm** 101,5

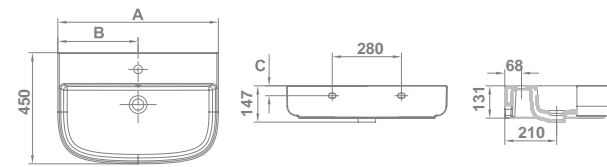

	A	B	C
<b>40020</b>	800	800	200
<b>40030</b>	900	900	200
<b>40040</b>	1000	1000	200



- €/u
- LAVABO DE SOBRE-ENCIMERA**  
Con rebosadero. Instalación sobre-encimera.
- 40025 **65x45 cm** 128,0
  - 40035 **60x45 cm** 116,5
  - 40045 **55x45 cm** 103,5

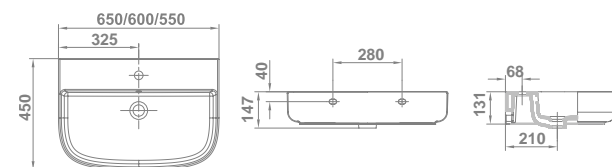

- €/u
- 40090 **LAVABO 91x46 cm** 168,0  
De sobremueble asimétrico.

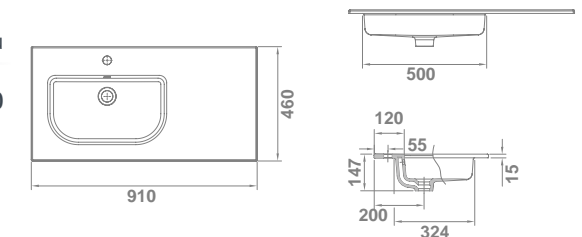

- €/u
- 40060 **LAVABO 101 x 46 x 1,5 cm** 188,5  
De sobremueble.

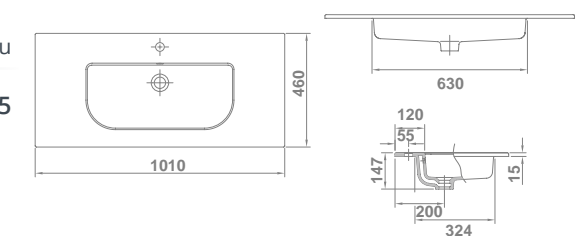

- €/u
- LAVAMANOS**  
Con rebosadero y juego de fijación.  
Instalación mural.
- 40080 **45x45 cm** 98,0
  - 40085 **45x45 cm** 100,0  
Instalación sobre-encimera.

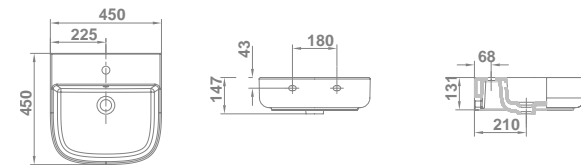

- €/u
- 40065 **LAVABO 81 x 46 x 1,5 cm** 146,5  
De sobremueble.

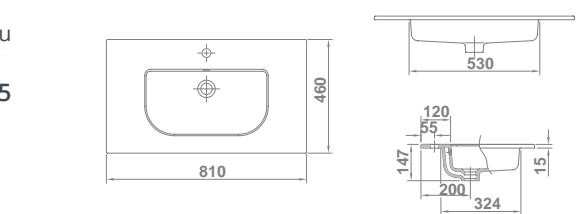











Nota: \*Compatible con pedestal Emma Square . Ver pág. 50. | Smart y semipedestal Smart. Ver pág. 86.

# Mid



€/u

- 40260 **INODORO PARA TANQUE BAJO BTW RIMLESS**   283,5  
60 x 36 cm  
Con salida dual y juego de anclaje. Incluye codo de instalación para salida vertical (Distancia a pared: 210 mm). Ver más posibilidades de instalación en repuestos. Para instalación con salida horizontal no es necesario codo.
- 40541 **TANQUE BAJO CON TAPA**   127,5  
  y mecanismo de doble pulsador. Alimentación inferior izquierda.
- 40546 **TANQUE BAJO CON TAPA**   127,5  
  y mecanismo de doble pulsador. Alimentación lateral.
- 51700 **ASIENTO FIJO** 55,5  
Bisagras cromadas.
- 51701 **ASIENTO CON CAÍDA AMORTIGUADA** 93,5
- CONJUNTO INODORO COMPLETO \*** 466,5



€/u

- 40160 **INODORO PARA TANQUE BAJO BTW**   263,0  
60 x 36 cm  
Con salida dual y juego de anclaje. Incluye codo de instalación para salida vertical (Distancia a pared: 210 mm). Ver más posibilidades de instalación en repuestos. Para instalación con salida horizontal no es necesario codo.
- 40540 **TANQUE BAJO CON TAPA**   117,5  
  y mecanismo de doble pulsador. Alimentación inferior izquierda.
- 40545 **TANQUE BAJO CON TAPA**   117,5  
  y mecanismo de doble pulsador. Alimentación lateral.
- 51700 **ASIENTO FIJO** 55,5  
Bisagras cromadas.
- 51701 **ASIENTO CON CAÍDA AMORTIGUADA** 93,5
- CONJUNTO INODORO COMPLETO \*\*** 436,0

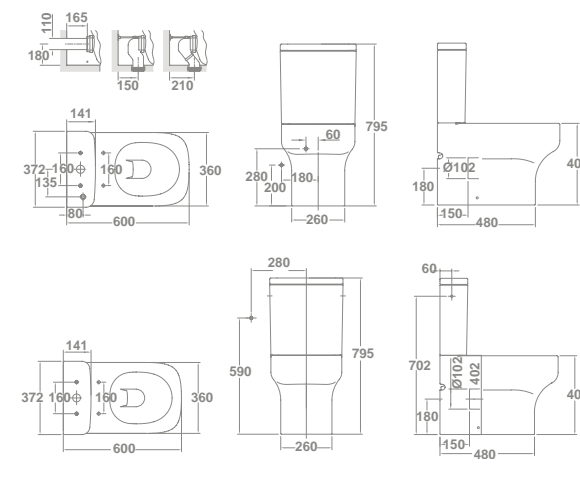
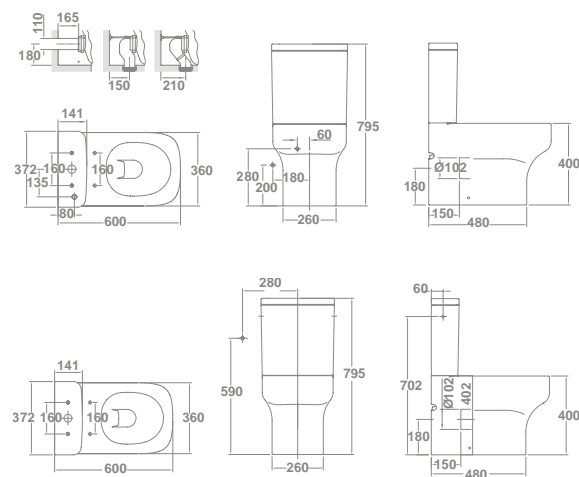

€/u

- 40360 **BIDÉ BTW**   146,5  
54 x 36 cm  
Con juego de anclaje.
- 51710 **TAPA PARA BIDÉ** 61,0

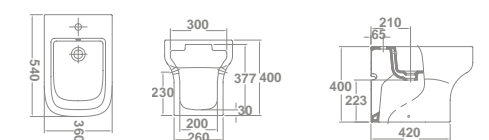

**Nota:** \*El conjunto inodoro completo está formado por: inodoro para tanque bajo BTW rimless, tanque completo de 4/2 litros y asiento fijo. BTW: Pegado a la pared. \*\*El conjunto Inodoro completo está formado por: inodoro para tanque bajo BTW, tanque completo 4,5/3L y asiento fijo.

# Mid suspendida



	€/u
40272 <b>INODORO SUSPENDIDO RIMLESS</b> 54 x 36 cm Con salida horizontal. Fijación oculta incluida.	28,9 18 246,5
51700 <b>ASIENTO FIJO</b>	55,5
51701 <b>ASIENTO CON CAÍDA AMORTIGUADA</b>	93,5
<b>CONJUNTO INODORO COMPLETO*</b>	<b>302,0</b>

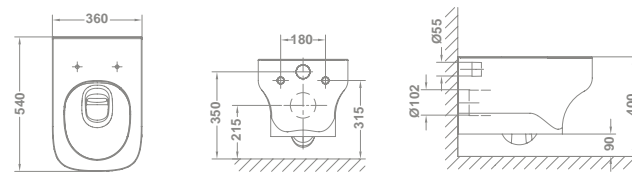

	€/u
55483 <b>WC FULL FRAME EON</b> Sistema de instalación para inodoro suspendido en pared ligera. Descarga de 6/3L, 4,5/3L y 4/2L. Accesorios de instalación incluidos. Profundidad mínima: 108/125 mm (DN90/DN100). Codo ø90 o 110 mm	14 20 244,0



5056369 <b>PULSADOR DE DOBLE DESCARGA EON 3</b> Cromo brillo.	48,5
<b>CONJUNTO COMPLETO**</b>	<b>594,5</b>

Otras posibilidades de instalación en páginas 148 - 161.



	€/u
40362 <b>BIDÉ SUSPENDIDO</b> 54 x 36 cm	21,5 18 190,0
51710 <b>TAPA PARA BIDÉ</b>	61,0

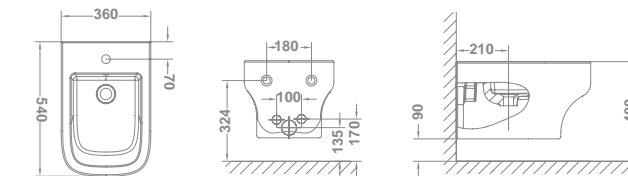

	€/u
55409 <b>BIDÉ FRAME EON COMPACT</b> Soporte para bidé. Accesorios de instalación incluidos. Profundidad mínima de 8 cm	12 30 244,0

Nota: \*El conjunto inodoro completo está formado por: inodoro suspendido rimless y asiento fijo. \*\*El conjunto completo está formado por: inodoro suspendido, asiento fijo, WC Full Frame Eon y pulsador de doble descarga Eon 3 Cromo Brillo.

# Mid

## + REPUESTOS Y ACCESORIOS

		€/u
40630	Tapa tanque Mid.	29,5
50703	Mecanismo de doble pulsador completo 4/2 litros (alimentación inferior).	61,8
50702	Mecanismo de doble pulsador completo 4/2 litros (alimentación lateral).	61,8
50372	Mecanismo de doble pulsador completo 4,5/3 litros (alimentación inferior).	54,7
50371	Mecanismo de doble pulsador completo 4,5/3 litros (alimentación lateral).	52,7
50491	Mecanismo de alimentación inferior.	20,0
50481	Mecanismo de alimentación lateral.	15,2
50355	Mecanismo de descarga 4,5/3 litros.	34,9
50520	Conjunto doble pulsador varillas roscadas.	13,4
53695	Juego de unión tanque-inodoro.	6,1
53296	Juego de fijación oculto para inodoro y bidé suspendidos.	38,1
53826	Conjunto bisagra completa asiento fijo Mid (bisagra y juego de fijación).	20,1
53825	Conjunto bisagra completa asiento amortiguado Mid (bisagra y juego de fijación).	60,0
53830	Juego de fijación asiento fijo y caída amortiguada Mid.	6,8
54213	Conjunto bisagra completa tapa bidé fija Mid (bisagra y juego de fijación).	35,4
53831	Juego de fijación tapa bidé Mid.	6,8
55380	Topes asientos Mid (bolsa de 6 unidades).	5,9
55380	Topes tapa bidé Mid (bolsa de 6 unidades).	5,9
50463	Codo curvo para inodoro tanque bajo salida vertical (para adaptar a distancia a pared de 210 mm). Recomendada instalación con varilla. Varilla no incluida.	27,2
53720	Codo curvo para inodoro tanque bajo salida vertical (para adaptar a distancia a pared de 150 mm). Recomendada instalación con varilla. Varilla no incluida.	17,2
50464	Varilla fijación codo curvo.	2,1
53294	Juego de anclaje inodoro y bidé.	5,4





col.  
**S m a r t**

# Smart



€/u

**LAVABO REDONDO**  
Con rebosadero y juego de fijación. Posibilidad de instalación con pedestal, semipedestal o mural.

25040	<b>60x48 cm</b>	20,1	24	109,0
25050	<b>55x45 cm</b>	16,2	24	102,0

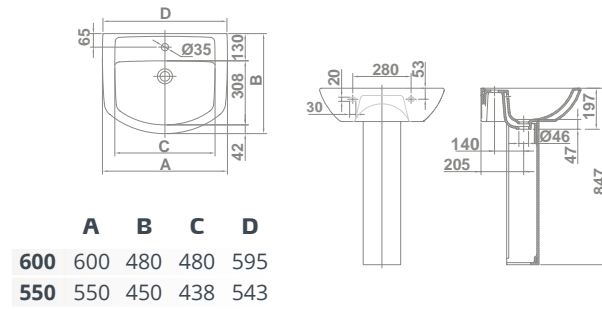

€/u

**LAVABO CUADRADO 60x48 cm**  
Con rebosadero y juego de fijación. Posibilidad de instalación con pedestal, semipedestal o mural.

25030	<b>LAVABO CUADRADO 60x48 cm</b>	19	24	120,0
-------	---------------------------------	----	----	-------

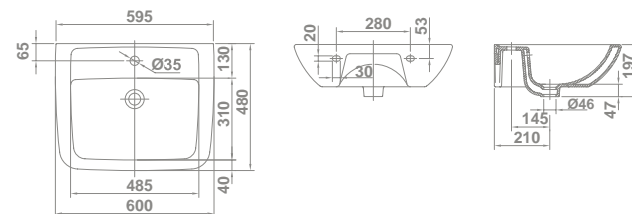

€/u

25430	<b>PEDESTAL</b>	12,1	24	67,5
25432	<b>SEMPIPEDESTAL</b> Con juego de fijación.	8	24	66,5

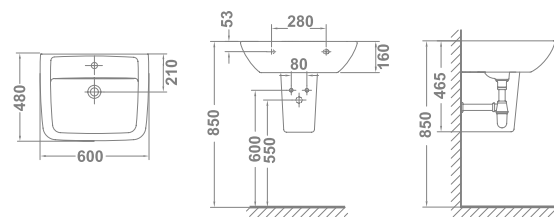

€/u

**LAVAMANOS 45x36 cm**  
Con juego de fijación. Posibilidad de instalación con pedestal, semipedestal o mural.

25090	<b>LAVAMANOS 45x36 cm</b>	11	24	71,5
-------	---------------------------	----	----	------

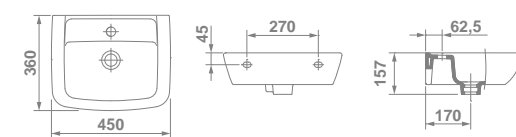

€/u

25140	<b>INODORO PARA TANQUE ALTO BTW</b> 55 x 35 cm Con salida dual y juego de anclaje. Para instalación con salida vertical es necesario codo. Para instalación con salida horizontal no es necesario codo. Ver ref. en respuestas.	23,2	24	230,0
51617	<b>ASIENTO FIJO</b>			62,0
51616	<b>ASIENTO CON CAÍDA AMORTIGUADA</b>			100,0
51615	<b>ASIENTO EXTRAÍBLE</b>			65,5
	<b>CONJUNTO INODORO COMPLETO*</b>			292,0

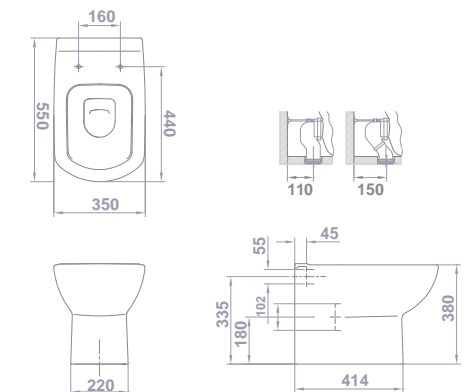

**Nota:** \*El conjunto inodoro completo está formado por: inodoro para tanque alto BTW y asiento fijo. BTW: Pegado a la pared.



# Smart



€/u

- 25180 **INODORO PARA TANQUE BAJO SH** 65 x 35 cm  
Con salida horizontal y juego de anclaje. 24,2 24 **159,0**
- 25150 **INODORO PARA TANQUE BAJO SV** 65 x 35 cm  
Con salida vertical y juego de anclaje. 24,3 24 **159,0**
- 25540 **TANQUE BAJO CON TAPA** y mecanismo de doble pulsador. Alimentación inferior izquierda. 12,8 24 **163,5**
- 51617 **ASIENTO FIJO** **62,0**
- 51616 **ASIENTO CON CAÍDA AMORTIGUADA** **100,0**
- 51615 **ASIENTO EXTRAÍBLE** **65,5**
- CONJUNTO INODORO COMPLETO\* 384,5**

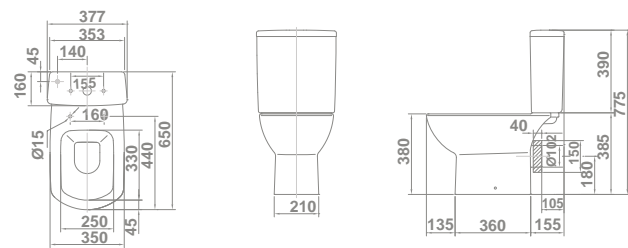

€/u

- 25162 **INODORO PARA TANQUE BAJO BTW COMPACT** 61,5 x 35 cm  
Con salida dual y juego de anclaje. Para instalación con salida vertical es necesario codo. Para instalación con salida horizontal no es necesario codo. Ver ref. en respuestos. 25,9 24 **180,0**
- 25581 **TANQUE BAJO CON TAPA** y mecanismo de doble pulsador. Alimentación inferior izquierda\*\*\*. 11 24 **167,0**
- 51617 **ASIENTO FIJO** **62,0**
- 51616 **ASIENTO CON CAÍDA AMORTIGUADA** **100,0**
- 51615 **ASIENTO EXTRAÍBLE** **65,5**
- CONJUNTO INODORO COMPLETO\*\*\* 409,0**

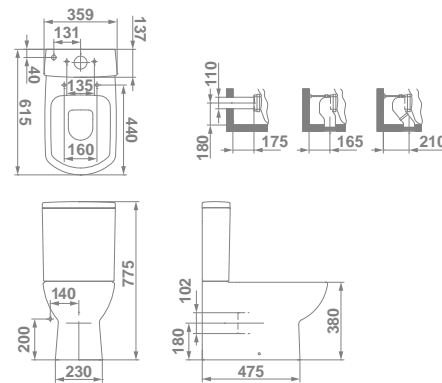

€/u

- 25360 **BIDÉ** 56 x 35 cm  
Con juego de anclaje. 20,4 24 **122,0**
- 51632 **TAPA PARA BIDÉ** **61,0**

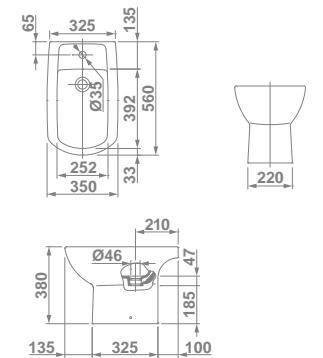

€/u

- 25366 **BIDÉ BTW** 56,5 x 35 cm  
Con juego de anclaje. 21,8 24 **141,0**
- 51632 **TAPA PARA BIDÉ** **61,0**

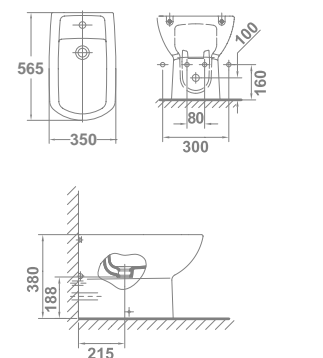

**Nota:** \*El conjunto inodoro completo está formado por: inodoro para tanque bajo, tanque completo y asiento fijo.  
\*\*Llave de corte exterior vista. \*\*\*El conjunto inodoro completo está formado por: inodoro para tanque bajo BTW, tanque completo y asiento fijo. BTW: Pegado a pared.

# Smart suspendida



	€/u
25172 <b>INODORO SUSPENDIDO</b> 53 x 35 cm Con salida horizontal.	208,0
51617 <b>ASIENTO FIJO</b>	62,0
51616 <b>ASIENTO CON CAÍDA AMORTIGUADA</b>	100,0
51615 <b>ASIENTO EXTRAÍBLE</b>	65,5
<b>CONJUNTO INODORO COMPLETO*</b>	<b>270,0</b>

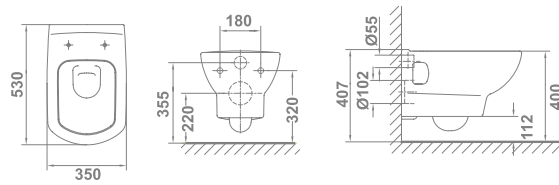

	€/u
55483 <b>WC FULL FRAME EON</b> Sistema de instalación para inodoro suspendido en pared ligera. Descarga de 6/3L, 4,5/3L y 4/2L. Accesorios de instalación incluidos. Profundidad mínima: 108/125 mm (DN90/DN100). Codo ø90 o 110 mm	244,0
5056369 <b>PULSADOR DE DOBLE DESCARGA EON 3</b> Cromo brillo.	48,5
<b>CONJUNTO COMPLETO**</b>	<b>562,5</b>

Otras posibilidades de instalación en páginas 148 - 161.



	€/u
25362 <b>BIDÉ SUSPENDIDO</b> 56,5 x 35 cm	168,0
51632 <b>TAPA PARA BIDÉ</b>	61,0

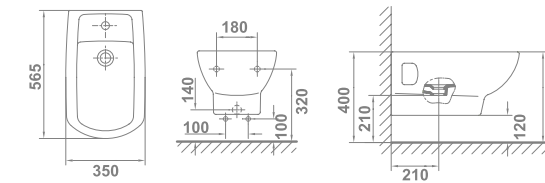

	€/u
55409 <b>BIDÉ FRAME EON COMPACT</b> Soporte para bidé. Accesorios de instalación incluidos. Profundidad mínima de 8 cm	244,0

Nota: \*El conjunto inodoro completo está formado por: inodoro suspendido y asiento fijo. \*\* El conjunto completo está formado por: inodoro suspendido, asiento fijo, WC Full Frame Eon y pulsador de doble descarga Eon 3 Cromo Brillo.

# Smart

## + REPUESTOS Y ACCESORIOS

		€/u
25630	Tapa tanque.	21,7
25636	Tapa tanque BTW.	25,8
50490	Mecanismo de doble pulsador completo 6/3 litros.	54,0
50460	Mecanismo de doble pulsador BTW completo 4,5/3 litros.	54,8
50491	Mecanismo de alimentación.	20,0
50492	Mecanismo de descarga.	34,9
50520	Conjunto doble pulsador varillas roscadas.	13,4
50495	Goma cierre descarga.	1,3
53690	Juego de unión tanque-inodoro.	5,1
53692	Juego de unión tanque-inodoro BTW.	6,1
53813	Conjunto bisagra completa asiento fijo Smart.	15,3
53811	Conjunto bisagra completa asiento extraíble Smart.	34,2
53812	Conjunto bisagra completo asiento con caída amortiguada Smart.	62,7
55295	Conjunto bisagra completa tapa bidé Smart.	23,5
53801	Juego de fijación asiento extraíble y caída amortiguada.	6,6
54292	Conjunto topes asiento.	12,5
54269	Topes tapa bidé (bolsa de 6 unidades). Modelo posterior a 2013.	6,0
53280	Juego de fijación lavabo.	5,6
53990	Juego de fijación semipedestal.	10,1
50463	Codo curvo para inodoro tanque alto BTW salida vertical (para adaptar a distancia a pared de 150 mm). Recomendada instalación con varilla. Varilla no incluida.	27,2
50463	Codo curvo para inodoro tanque bajo BTW salida vertical (para adaptar a distancia a pared de 210 mm). Recomendada instalación con varilla. Varilla no incluida.	27,2
53720	Codo curvo para inodoro tanque alto BTW salida vertical (para adaptar a distancia a pared de 110 mm). Recomendada instalación con varilla. Varilla no incluida.	17,2
53720	Codo curvo para inodoro tanque bajo BTW salida vertical (para adaptar a distancia a pared de 165 mm). Recomendada instalación con varilla. Varilla no incluida.	17,2
50464	Varilla fijación codo curvo.	2,1
53710	Codo recto para desagüe inodoro.	10,0
53294	Juego de anclaje inodoroo bidé.	5,4





col.  
**Street  
Square**

# Street Square



				€/u
<b>LAVABO</b>				
Con rebosadero y juego de fijación. Posibilidad de instalación con semipedestal* o mural.				
05030	<b>60x45 cm</b>	14,2	40	100,0
05040	<b>55x45 cm</b>	13,8	24	90,0
05432	<b>SEMIPEDESTAL</b>	7,8	24	64,0
Con juego de fijación.				

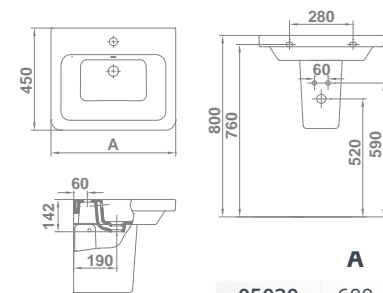

	<b>A</b>
05030	600
05040	550



				€/u
<b>LAVABO DE ENCIMERA 60x45 cm</b>				
Con rebosadero. Instalación de encimera pegado a la pared. Plantilla de corte de 53,6x41,8 cm				
05035		14,2	40	102,0

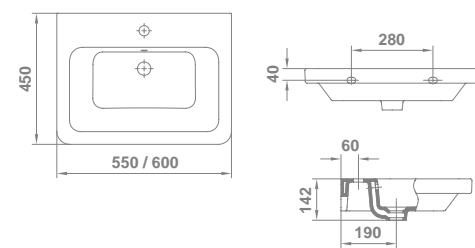

<b>LAVABO DE ENCIMERA 55x45 cm</b>				
Con rebosadero. Instalación de encimera pegado a la pared. Plantilla de corte de 48,7x41,8 cm				
05045		13,8	24	92,0



\*Compatibles con pedestal Smart

# Street Square



	€/u
05120 <b>INODORO PARA TANQUE BAJO</b> 64 x 35 cm Con salida dual y juego de anclaje.	154,5
05540 <b>TANQUE BAJO CON TAPA</b> y mecanismo de doble pulsador. Alimentación inferior izquierda.	111,5
05545 <b>TANQUE BAJO CON TAPA</b> y mecanismo de doble pulsador. Alimentación lateral.	111,5
51326 <b>ASIENTO SLIM FIJO</b>	51,5
51327 <b>ASIENTO CON CAÍDA AMORTIGUADA SLIM</b>	85,5
51322 <b>ASIENTO FIJO</b>	51,5
51323 <b>ASIENTO CON CAÍDA AMORTIGUADA</b>	85,5
<b>CONJUNTO INODORO COMPLETO*</b>	<b>317,5</b>

	€/u
05160 <b>INODORO PARA TANQUE BAJO BTW</b> 60 x 35 cm Con salida dual y juego de anclaje. Para instalación con salida vertical es necesario codo. Para instalación con salida horizontal no es necesario codo. Ver ref. en respuestas.	193,0
05581 <b>TANQUE BAJO CON TAPA</b> y mecanismo de doble pulsador. Alimentación inferior izquierda.	111,5
05580 <b>TANQUE BAJO CON TAPA</b> y mecanismo de doble pulsador. Alimentación lateral.	111,5
51326 <b>ASIENTO SLIM FIJO</b>	51,5
51327 <b>ASIENTO CON CAÍDA AMORTIGUADA SLIM</b>	85,5
51322 <b>ASIENTO FIJO</b>	51,5
51323 <b>ASIENTO CON CAÍDA AMORTIGUADA</b>	85,5
<b>CONJUNTO INODORO COMPLETO*</b>	<b>356,0</b>

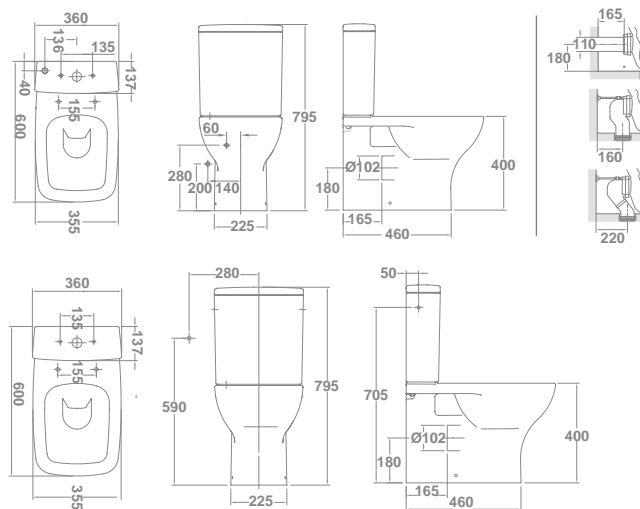
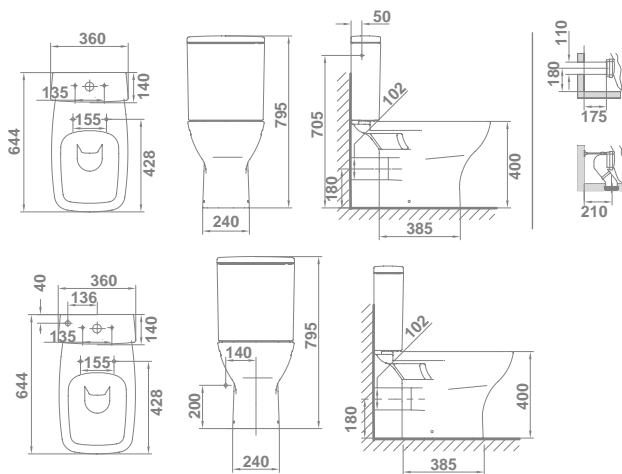

	€/u
05360 <b>BIDÉ</b> 53 x 35 cm Con juego de anclaje.	103,0

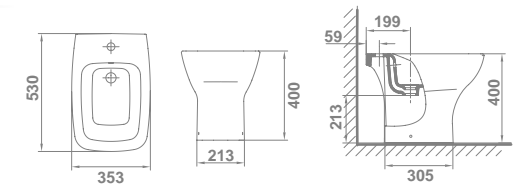

	€/u
05366 <b>BIDÉ BTW</b> 53 x 35 cm Con juego de anclaje.	121,0

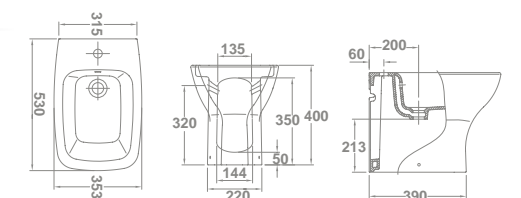

Nota: \*\*El conjunto inodoro completo está formado por: inodoro para tanque bajo, tanque completo y asiento fijo.  
BTW: Pegado a la pared.

# Street Square suspendida



	€/u
05172 <b>INODORO SUSPENDIDO</b> 53 x 35 cm Con salida horizontal.	184,0
51326 <b>ASIENTO FIJO SLIM</b>	51,5
51327 <b>ASIENTO CON CAÍDA AMORTIGUADA SLIM</b>	85,5
51322 <b>ASIENTO FIJO</b>	51,5
51323 <b>ASIENTO CON CAÍDA AMORTIGUADA</b>	85,5
<b>CONJUNTO INODORO COMPLETO*</b>	<b>235,5</b>

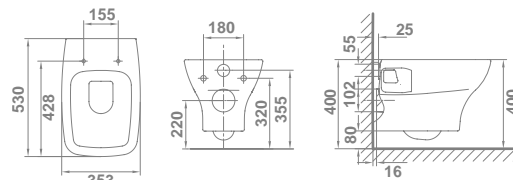

	€/u
55483 <b>WC FULL FRAME EON</b> Sistema de instalación para inodoro suspendido en pared ligera. Descarga de 6/3L, 4,5/3L y 4/2L. Accesorios de instalación incluidos. Profundidad mínima: 108/125 mm (DN90/DN100). Codo ø90 o 110 mm	244,0



5056369 <b>PULSADOR DE DOBLE DESCARGA EON 3</b> Cromo brillo.	48,5
<b>CONJUNTO COMPLETO**</b>	<b>528,0</b>

Otras posibilidades de instalación en páginas 148 - 161.



	€/u
05362 <b>BIDÉ SUSPENDIDO</b> 53 x 35 cm	151,0

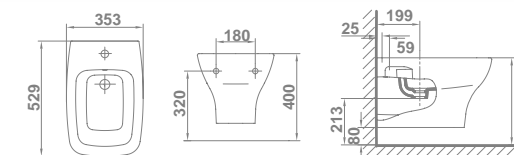

	€/u
55409 <b>BIDÉ FRAME EON COMPACT</b> Soporte para bidé. Accesorios de instalación incluidos. Profundidad mínima de 8 cm	244,0

**Nota:** \*El conjunto inodoro completo está formado por: inodoro suspendido y asiento fijo. \*\*El conjunto completo está formado por: inodoro suspendido, asiento fijo, WC Full Frame Eon y pulsador de doble descarga Eon 3 Cromo Brillo.

# Street Square

## + REPUESTOS Y ACCESORIOS

		€/u
25636	Tapa tanque.	25,8
<b>Alimentación inferior</b>		
50490	Mecanismo de doble pulsador completo 4,5/3 litros.	54,0
50460	Mecanismo de doble pulsador BTW completo 4,5/3 litros.	54,8
50491	Mecanismo de alimentación inferior.	20,0
<b>Alimentación lateral</b>		
50489	Mecanismo de doble pulsador completo 4,5/3 litros.	50,9
50459	Mecanismo de doble pulsador BTW completo 4,5/3 litros.	51,7
50481	Mecanismo de alimentación lateral.	15,2
50492	Mecanismo de descarga.	34,9
50520	Conjunto doble pulsador varillas roscadas.	13,4
50495	Goma cierre descarga.	1,3
53690	Juego de unión tanque-inodoro.	5,1
53692	Juego de unión tanque-inodoro BTW.	6,1
53835	Conjunto bisagra completa asiento fijo (bisagra y juego de fijación).	21,3
53836	Conjunto bisagra completo asiento amortiguado (bisagra y juego de fijación).	50,2
53837	Juego de fijación asiento fijo Street Square.	8,5
53801	Juego de fijación asiento amortiguado Street Square.	6,6
54269	Topes asiento.	6,0
53630	Juego de fijación semipedestal.	5,6
53280	Juego de fijación lavabo.	5,6
50463	Codo curvo para inodoro tanque bajo salida vertical (para adaptar a distancia a pared de 210 mm). Recomendada instalación con varilla. Varilla no incluida.	27,2
50463	Codo curvo para inodoro tanque bajo BTW salida vertical (para adaptar a distancia a pared de 220 mm). Recomendada instalación con varilla. Varilla no incluida.	27,2
53720	Codo curvo para inodoro tanque alto BTW salida vertical (para adaptar a distancia a pared de 160 mm). Recomendada instalación con varilla. Varilla no incluida.	17,2
53294	Juego de anclaje inodoroo bidé.	5,4
50464	Varilla fijación codo curvo.	2,1







col.  
**Aris**

# Arís



€/u

**LAVABO**  
Con rebosadero y juego de fijación.  
Posibilidad de instalación con pedestal, semipedestal o mural.

47030 **60x49 cm** **64,0**

47020 **55x49 cm** **62,5**

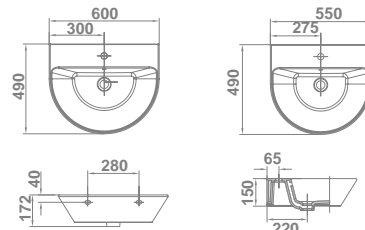

€/u

47430 **PEDESTAL** **47,2**

47432 **SEMPIPEDESTAL** **47,2**

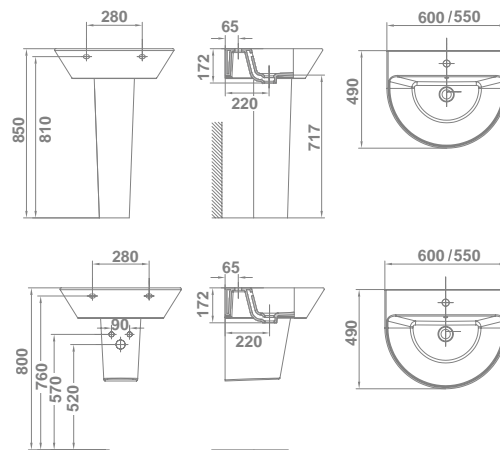

€/u

47010 **LAVAMANOS 40x40 cm** **54,5**  
Con rebosadero y juego de fijación.  
Posibilidad de instalación con pedestal o mural.

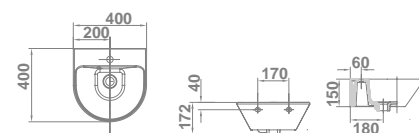

€/u

47035 **LAVABO DE SOBRE-ENCIMERA 60x49 cm** **65,0**  
Con rebosadero. Instalación sobre-encimera.

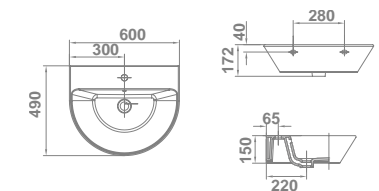

€/u

47025 **LAVABO DE SOBRE-ENCIMERA 55x49 cm** **63,5**  
Con rebosadero y juego de fijación. Instalación sobre-encimera.

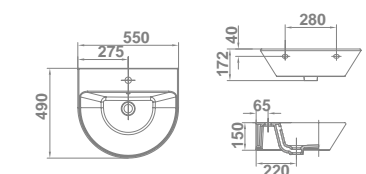

# Aris <sup>N</sup>

Disponibilidad 2º semestre de 2024



	€/u
47230 <b>INODORO PARA TANQUE ALTO RIMLESS SV</b> <sup>25,5</sup> <sup>24</sup> 54x36 cm Con salida vertical y juego de anclaje	93,0
47270 <b>INODORO PARA TANQUE ALTO RIMLESS SH</b> <sup>22</sup> <sup>24</sup> 54x36 cm Con salida horizontal y juego de anclaje	93,0
51703 <b>ASIENTO FIJO</b>	41,2
51704 <b>ASIENTO CON CAÍDA AMORTIGUADA</b>	65,0
<b>CONJUNTO INODORO COMPLETO*</b>	<b>134,2</b>

	€/u
47250 <b>INODORO PARA TANQUE BAJO RIMLESS SV</b> <sup>24,4</sup> <sup>24</sup> 66 x 36 cm Con salida vertical y juego de anclaje.	88,1
47280 <b>INODORO PARA TANQUE BAJO RIMLESS SH</b> <sup>24,5</sup> <sup>24</sup> 66 x 36 cm Con salida horizontal y juego de anclaje.	88,1
47530 <b>TANQUE BAJO CON TAPA</b> <sup>12,5</sup> <sup>24</sup> <sup>4,5L</sup> <sup>3L</sup> y mecanismo de doble pulsado. Alimentación inferior izquierda.	117,5
47535 <b>TANQUE BAJO CON TAPA</b> <sup>12,5</sup> <sup>24</sup> <sup>4,5L</sup> <sup>3L</sup> y mecanismo de doble pulsado. Alimentación lateral.	117,5
51703 <b>ASIENTO FIJO</b>	41,2
51704 <b>ASIENTO CON CAÍDA AMORTIGUADA</b>	65,0
<b>CONJUNTO INODORO COMPLETO*</b>	<b>246,8</b>

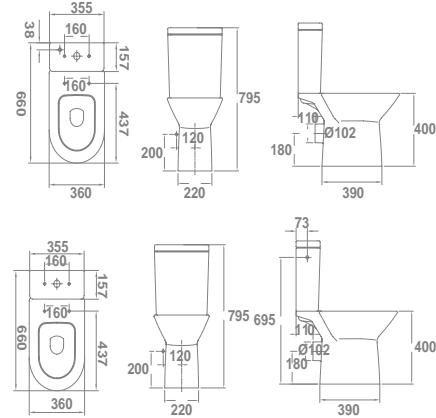
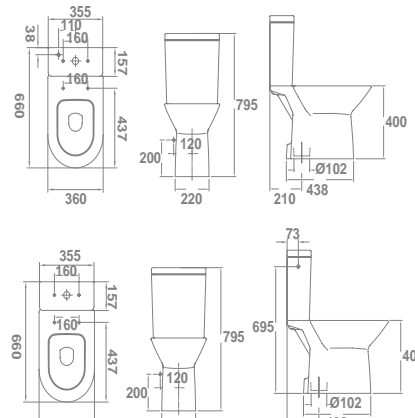
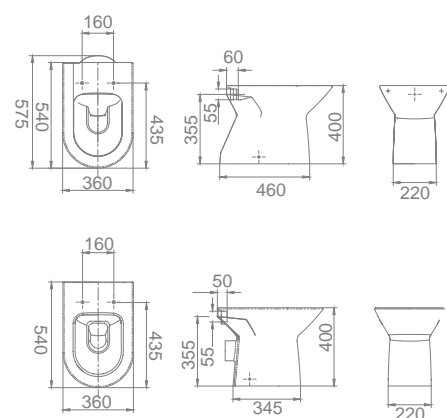

	€/u
47360 <b>BIDÉ</b> <sup>17,4</sup> <sup>24</sup> 54 x 35 cm Con juego de anclaje.	73,6

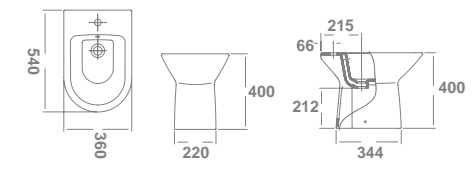

Nota: \*El conjunto inodoro completo está formado por: inodoro para tanque bajo rimless, tanque completo 4,5/3 litros y asiento fijo.

# Aris suspendida galaVIP N

Disponibilidad 2º semestre de 2024



	€/u
47272 <b>INODORO SUSPENDIDO RIMLESS</b> <small>Novedad</small> 67x35,5 cm Con salida horizontal.	140,0
51703 <b>ASIENTO FIJO</b>	41,2
51704 <b>ASIENTO CON CAÍDA AMORTIGUADA</b>	65,0
<b>CONJUNTO INODORO COMPLETO*</b>	<b>181,2</b>

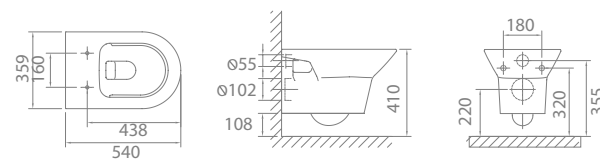

	€/u
55483 <b>WC FULL FRAME EON</b> Sistema de instalación para inodoro suspendido en pared ligera. Descarga de 6/3L, 4,5/3L y 4/2L. Accesorios de instalación incluidos. Profundidad mínima: 108/125 mm (DN90/DN100). Codo ø90 o 110 mm	244,0
5056369 <b>PULSADOR DE DOBLE DESCARGA EON 3</b> Cromo brillo.	48,5
<b>CONJUNTO COMPLETO**</b>	<b>473,7</b>

Otras posibilidades de instalación en páginas 148 - 161.

**Nota:** \*El conjunto inodoro completo está formado por: inodoro suspendido y asiento fijo. \*\*El conjunto completo está formado por: inodoro suspendido, asiento fijo, WC Full Frame Eon y pulsador de doble descarga Eon 3 Cromo Brillo.



	€/u
47362 <b>BIDÉ SUSPENDIDO</b> <small>Novedad</small> 54X36 cm	125,0

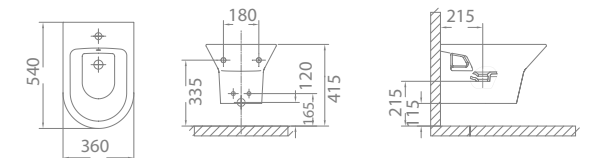

	€/u
55409 <b>BIDÉ FRAME EON COMPACT</b> Soporte para bidé. Accesorios de instalación incluidos. Profundidad mínima de 8 cm	244,0

# Aris

## + REPUESTOS Y ACCESORIOS €/u

47630 Tapa tanque. 20,1

### Alimentación inferior

50374 Mecanismo de doble pulsador completo 4,5/3 litros. 101,9

50491 Mecanismo de alimentación inferior. 20,0

### Alimentación lateral

50373 Mecanismo de doble pulsador completo 4,5/3 litros. 101,9

50481 Mecanismo de alimentación lateral. 15,2

50355 Mecanismo de descarga 4,5/3 litros. 34,9

50520 Conjunto doble pulsador varillas roscadas. 13,4

50495 Goma cierre descarga. 1,3

53690 Juego de unión tanque-inodoro. 5,1

53835 Conjunto bisagra completa asiento fijo (bisagra y juego de fijación). 21,3

53839 Conjunto bisagra completo asiento amortiguado (bisagra y juego de fijación). 4,9

53837 Juego de fijación asiento (fijo y amortiguado). 8,5

55332 Topes asiento. 6,0

53990 Juego de fijación semipedestal. 10,1

53280 Juego de fijación lavabo. 5,6

53294 Juego de anclaje inodoro o bidé. 5,4





col.  
**Elia**

# Elia

En venta hasta fin de existencias



				€/u
18030	<b>65x51 cm</b>	18,5	40	70,0
18040	<b>60x48,5 cm</b>	17	40	66,0
18050	<b>55x45,5 cm</b>	14,6	40	65,0
18430	<b>PEDESTAL</b>	10,6	40	46,1

**LAVABO**  
Con rebosadero y juego de fijación.  
Posibilidad de instalación con pedestal,  
semipedestal o mural.

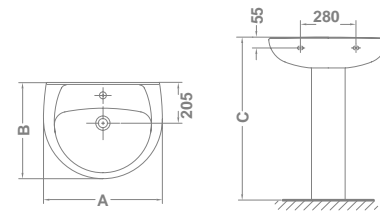

	A	B	C
18030	650	650	510
18040	600	600	485
18050	550	550	455



				€/u
18432	<b>SEMIPEDESTAL</b>	7,3	24	47,6

Con juego de fijación.

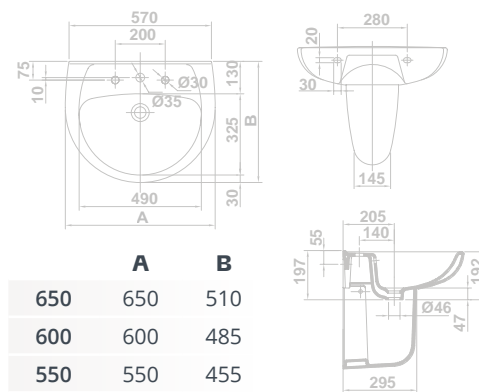

	A	B
650	650	510
600	600	485
550	550	455



				€/u
18070	<b>LAVABO DE SEMIEMPOTRAR</b>	13,3	40	141,0

**55x45,5 cm**  
Con rebosadero.

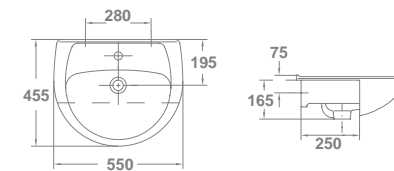

En venta hasta fin de existencias



				€/u
18130	<b>INODORO PARA TANQUE ALTO SV</b>	16,3	40	88,0
	47x35 cm			Con salida vertical y juego de anclaje.
18170	<b>INODORO PARA TANQUE ALTO SH</b>	14,8	24	88,0
	47x35 cm			Con salida vertical y juego de anclaje.
51370	<b>ASIENTO FIJO</b>			40,5
51382	<b>ASIENTO FIJO PP</b>			29,5
51379	<b>ASIENTO CON CAÍDA AMORTIGUADA</b>			64,0
	<b>CONJUNTO INODORO COMPLETO*</b>			<b>117,5</b>

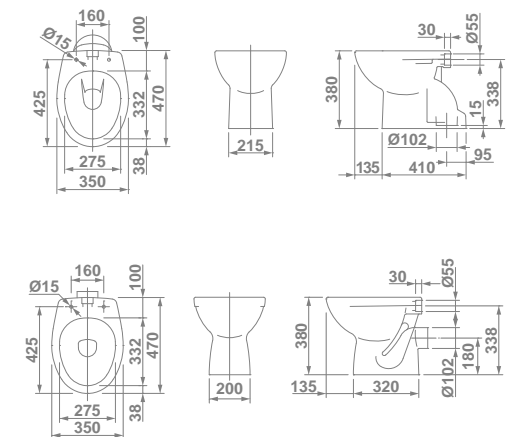

**Nota:** \*El conjunto inodoro completo está formado por: inodoro para tanque alto y asiento fijo PP.

# Elia

En venta hasta fin de existencias



	€/u
18150 <b>INODORO PARA TANQUE BAJO SV</b> 66 x 35 cm Con salida vertical y juego de anclaje.	85,0
18180 <b>INODORO PARA TANQUE BAJO SH</b> 66 x 35 cm Con salida horizontal y juego de anclaje.	85,0
18544 <b>TANQUE BAJO CON TAPA</b> y mecanismo de doble pulsador. Alimentación inferior izquierda.	119,5
18541 <b>TANQUE BAJO CON TAPA</b> y mecanismo de pulsador simple. Alimentación lateral superior.	113,5
51370 <b>ASIENTO FIJO</b>	40,5
51382 <b>ASIENTO FIJO PP</b>	29,5
51379 <b>ASIENTO CON CAÍDA AMORTIGUADA</b>	64,0
<b>CONJUNTO INODORO COMPLETO AI</b>	<b>234,0</b>
<b>CONJUNTO INODORO COMPLETO AL</b>	<b>228,0</b>

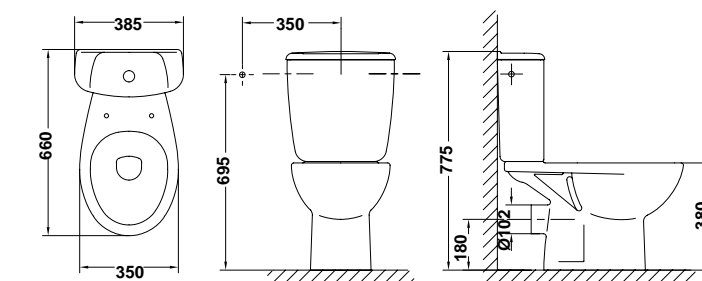
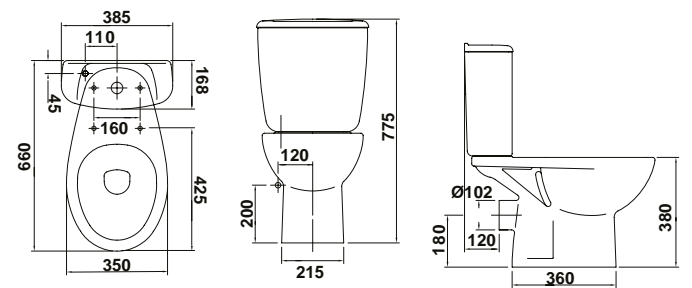
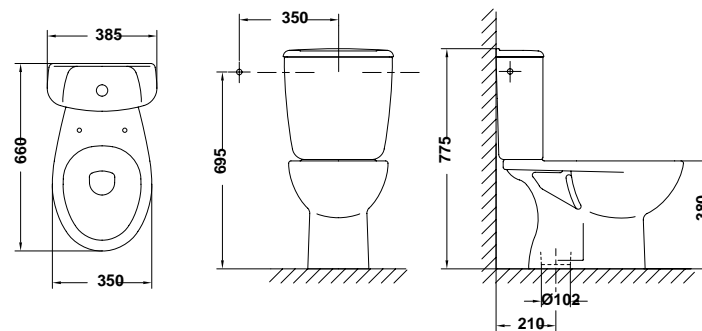
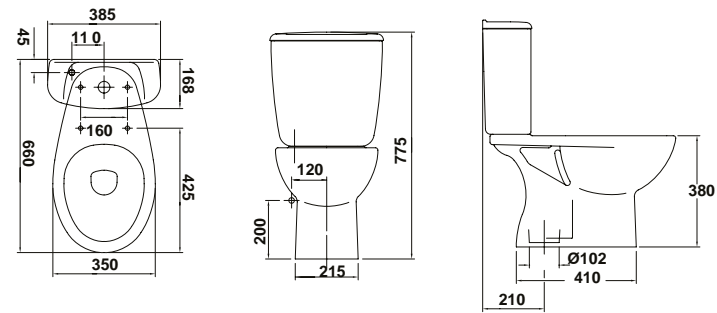

	€/u
18360 <b>BIDÉ</b> 53,5 x 35 cm Con juego de anclaje.	72,0
51371 <b>TAPA PARA BIDÉ</b>	49,0

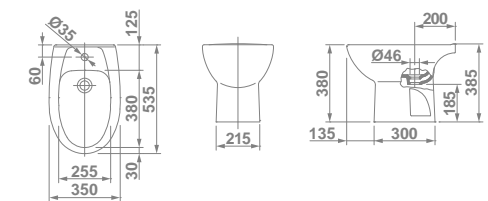



Nota: \*El conjunto inodoro completo está formado por: inodoro para tanque bajo, tanque completo A.I. y asiento fijo PP.  
\*\*El conjunto inodoro completo está formado por: inodoro para tanque bajo, tanque completo A.L. y asiento fijo PP.



# Elia suspendida

En venta hasta fin de existencias



	€/u
18172 <b>INODORO SUSPENDIDO</b>   52,5 x 35 cm Con salida horizontal.	134,0
51370 <b>ASIENTO FIJO</b>	40,5
51382 <b>ASIENTO FIJO PP</b>	29,5
51379 <b>ASIENTO CON CAÍDA AMORTIGUADA</b>	64,0
<b>CONJUNTO INODORO COMPLETO</b>	<b>163,5</b>

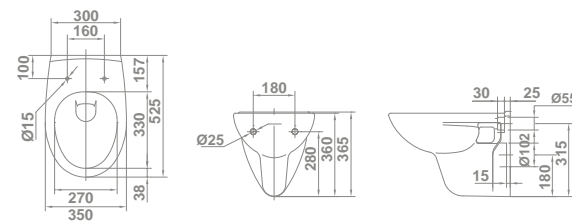

	€/u
55483 <b>WC FULL FRAME EON</b>   Sistema de instalación para inodoro suspendido en pared ligera. Descarga de 6/3L, 4,5/3L y 4/2L. Accesorios de instalación incluidos. Profundidad mínima: 108/125 mm (DN90/DN100). Codo ø90 o 110 mm	244,0
5056369 <b>PULSADOR DE DOBLE DESCARGA EON 3</b> Cromo brillo.	48,5
<b>CONJUNTO COMPLETO**</b>	<b>456,0</b>

Otras posibilidades de instalación en páginas 148 - 161.

**Nota:** \*El conjunto inodoro completo está formado por: inodoro suspendido y asiento fijo PP. El bidé Elia referencia 18362 no acepta tapa para bidé. \*\*El conjunto completo está formado por: inodoro suspendido, asiento fijo PP, WC Full Frame Eon y pulsador de doble descarga Eon 3 Cromo Brillo.



	€/u
18362 <b>BIDÉ SUSPENDIDO</b>   54,5 x 35 cm	120,5

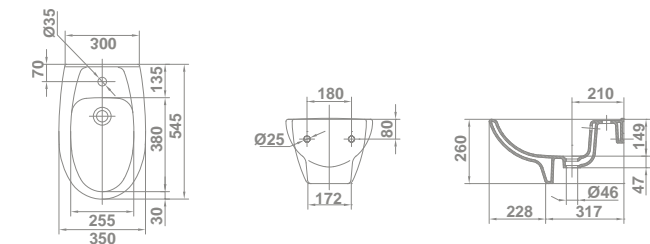

	€/u
55409 <b>BIDÉ FRAME EON COMPACT</b>   Soporte para bidé. Accesorios de instalación incluidos. Profundidad mínima de 8 cm	244,0

# Elia

En venta hasta fin de existencias

## + REPUESTOS Y ACCESORIOS €/u

18630 Tapa tanque. 20,5

### Alimentación inferior

50490 Mecanismo de doble pulsador completo 6/3 litros. 54,0

50491 Mecanismo de alimentación inferior. 20,0

50492 Mecanismo de descarga. 34,9

50493 Conjunto doble pulsador. 13,4

50520 Conjunto doble pulsador varillas roscadas. 13,4

50495 Goma cierre descarga. 1,3

53690 Juego de unión tanque-inodoro. 5,1

### Alimentación lateral

50480 Mecanismo de pulsador simple completo. 45,1

50481 Mecanismo de alimentación lateral. 15,2

50482 Mecanismo de descarga. 30,2

50483 Conjunto pulsador. 10,1

50485 Varilla descarga pulsador. 1,1

50486 Goma cierre descarga. 1,1

53690 Juego de unión tanque-inodoro. 5,1

53841 Juego de fijación asiento fijo. 6,2

53842 Juego de fijación asiento amortiguado. 45,3

55329 Juego de fijación tapa de bidé. 5,7

55332 Topes asiento (bolsa de 6 unidades). 6,0

53840 Juego de fijación asiento. Modelo anterior a 2007. 5,9

55331 Topes asiento (bolsa de 6 unidades). Modelo anterior a 2007. 6,2

53280 Juego de fijación lavabo. 5,6

53290 Juego de anclaje inodoro o bidé. 3,0

53990 Juego de fijación semipedestal. 10,1

53710 Codo recto para desagüe inodoro. 10,0





col.  
**L i z z**

# Lizz



				€/u
<b>LAVABO</b>				
Con rebosadero y juego de fijación. Posibilidad de instalación con pedestal, semipedestal o mural.				
57030	<b>60x45 cm</b>	16	40	54,6
57020	<b>55x45 cm</b>	13,9	40	50,0
57010	<b>50x40 cm</b>	12	40	49,2

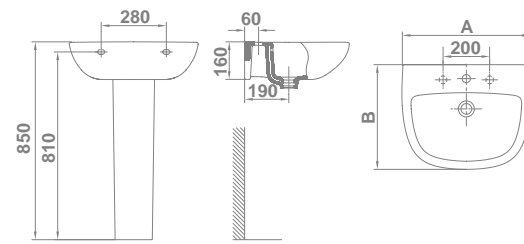

	A	B
57030	600	450
57020	550	450
57010	500	400



				€/u
57430	<b>PEDESTAL</b>	8,8	40	33,5
57432	<b>SEMIPEDESTAL</b>	6,5	48	33,5

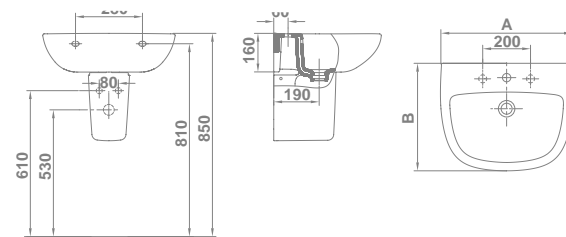

Disponibilidad 2º trimestre de 2024



				€/u
57230	<b>INODORO PARA TANQUE ALTO RIMLESS SV</b>	16	40	82,0
	53x35,5 cm			
	Con salida vertical y juego de anclaje.			
57270	<b>INODORO PARA TANQUE ALTO RIMLESS SH</b>	15	40	82,0
	53x35,5 cm			
	Con salida horizontal y juego de anclaje.			
51374	<b>ASIENTO FIJO PP</b>			28,6
51375	<b>ASIENTO CON CAÍDA AMORTIGUADA PP</b>			43,9
	<b>CONJUNTO INODORO COMPLETO*</b>			<b>110,6</b>

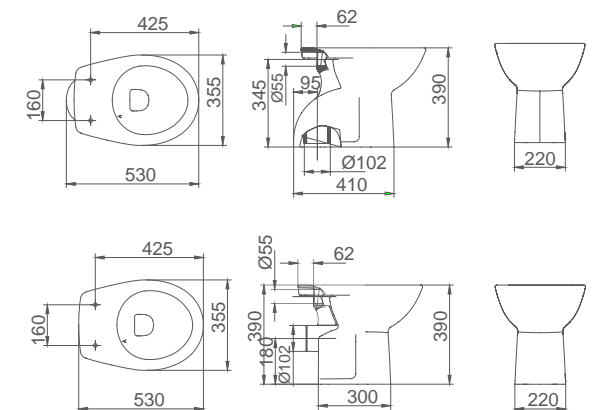

# Lizz <sup>N</sup>

Disponibilidad 2º semestre de 2024

En venta hasta fin de existencias



Modelo	Descripción	Características	€/u
57250	<b>INODORO PARA TANQUE BAJO RIMLESS SV</b> 67x35,5 cm Con salida vertical y juego de anclaje.	16, 40	71,5
57280	<b>INODORO PARA TANQUE BAJO RIMLESS SH</b> 67x35,5 cm Con salida horizontal y juego de anclaje.	16, 40	71,5
57541	<b>TANQUE BAJO CON TAPA</b> y mecanismo de doble pulsador. Alimentación inferior izquierda.	10, 40, 4.5L, 3L	95,5
57547	<b>TANQUE BAJO CON TAPA</b> y mecanismo de doble pulsador. Alimentación lateral.	10, 40, 4.5L, 3L	95,5
51374	<b>ASIENTO FIJO PP</b>		28,6
51375	<b>ASIENTO CON CAÍDA AMORTIGUADA PP</b>		43,9
51365	<b>ASIENTO FIJO SLIM</b>		50,3
51366	<b>ASIENTO CON CAÍDA AMORTIGUADA SLIM</b>		58,4

**CONJUNTO INODORO COMPLETO\* 195,6**

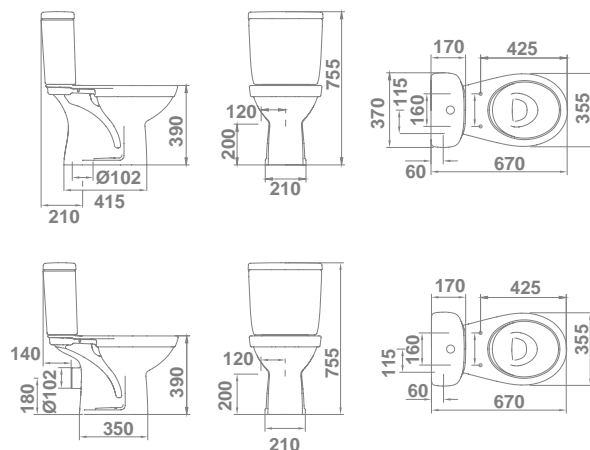

Modelo	Descripción	Características	€/u
57150	<b>INODORO PARA TANQUE BAJO SV</b> 67 x 35,5 cm Con salida vertical y juego de anclaje.	17,9, 40	71,5
57180	<b>INODORO PARA TANQUE BAJO SH</b> 67 x 35,5 cm Con salida horizontal y juego de anclaje.	17,9, 40	71,5
57540	<b>TANQUE BAJO CON TAPA</b> y mecanismo de doble pulsador. Alimentación inferior izquierda.	9,9, 40, 6L, 3L	95,5
57545	<b>TANQUE BAJO CON TAPA</b> y mecanismo de pulsador simple. Alimentación lateral.	9,9, 40, 6L, 3L	95,5
51374	<b>ASIENTO FIJO PP</b>		28,6
51375	<b>ASIENTO CON CAÍDA AMORTIGUADA PP</b>		43,9
51365	<b>ASIENTO FIJO SLIM</b>		50,3
51366	<b>ASIENTO CON CAÍDA AMORTIGUADA SLIM</b>		58,4

**CONJUNTO INODORO COMPLETO\* 195,6**

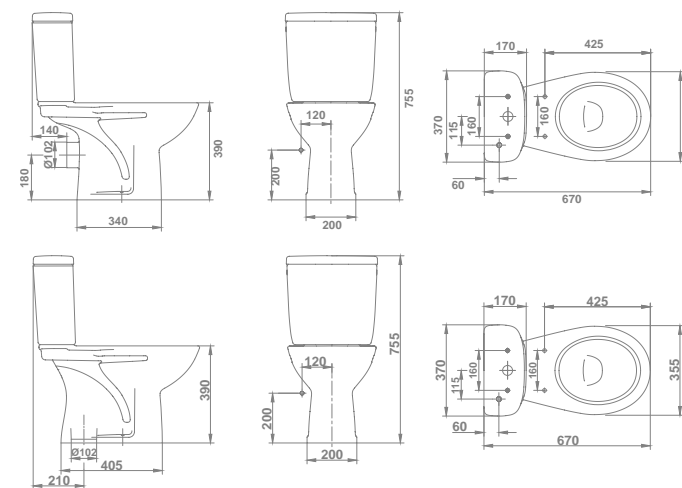

Modelo	Descripción	Características	€/u
57360	<b>BIDÉ</b> 53 x 35,5 cm Con juego de anclaje.	14,6, 40	58,7

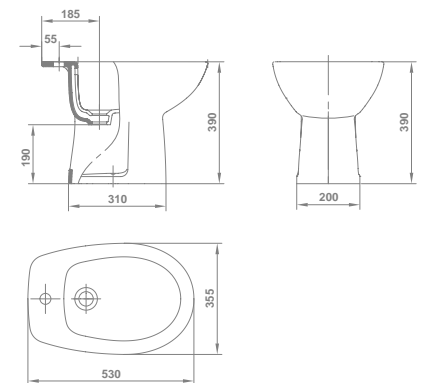

Nota: \*El conjunto inodoro completo está formado por: inodoro para tanque bajo, tanque completo de doble pulsador y asiento fijo PP.

# Lizz suspendida <sup>N</sup>

Disponibilidad 2º semestre de 2024



	€/u
57272 <b>INODORO SUSPENDIDO RIMLESS</b> <sup>Novedad</sup>   52x35,5 cm	82,0
51374 <b>ASIENTO FIJO PP</b>	28,6
51375 <b>ASIENTO CON CAÍDA AMORTIGUADA PP</b>	43,9
51365 <b>ASIENTO FIJO SLIM</b>	50,3
51366 <b>ASIENTO CON CAÍDA AMORTIGUADA SLIM</b>	58,4
<b>CONJUNTO INODORO COMPLETO*</b>	<b>110.6</b>

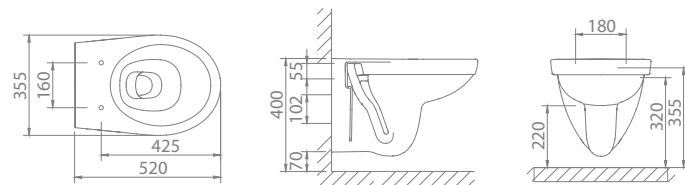

	€/u
55483 <b>WC FULL FRAME EON</b>   Sistema de instalación para inodoro suspendido en pared ligera. Descarga de 6/3L, 4,5/3L y 4/2L. Accesorios de instalación incluidos. Profundidad mínima: 108/125 mm (DN90/DN100). Codo ø90 o 110 mm	244,0
5056369 <b>PULSADOR DE DOBLE DESCARGA EON 3</b> Cromo brillo.	48,5
<b>CONJUNTO COMPLETO**</b>	<b>403.1</b>

Otras posibilidades de instalación en páginas 140 - 145.



**Nota:** \*El conjunto inodoro completo está formado por: inodoro suspendido y asiento fijo PP. El bidé Elia referencia 18362 no acepta tapa para bidé. \*\*El conjunto completo está formado por: inodoro suspendido, asiento fijo PP, WC Full Frame Eon y pulsador de doble descarga Eon 3 Cromo Brillo.

# Lizz

## + REPUESTOS Y ACCESORIOS €/u

### Alimentación inferior

50409 Mecanismo de doble pulsador completo 6/3 litros. 30,0

50505 Mecanismo de alimentación inferior. 14,4

### Alimentación lateral

50411 Mecanismo de doble pulsador completo 6/3 litros. 30,0

50501 Mecanismo de alimentación lateral. 14,4

50502 Mecanismo de descarga 6/3 litros. 20,4

50503 Conjunto pulsador completo. 12,1

50504 Juego de unión tanque-inodoro. 5,5

53280 Juego de fijación lavabo. 5,6

53630 Juego de fijación semipedestal. 5,6

53290 Juego de anclaje inodoro o bidé. 3,0







col.  
**B a b y W C**



# Baby WC



10064 **INODORO PARA TANQUE ALTO BTW**   €/u **172,0**



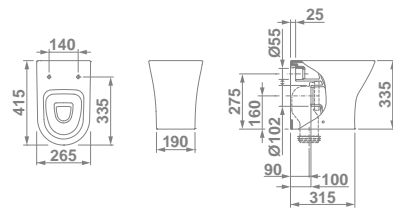

41,5 x 26,5 cm  
Con salida dual y juego de anclaje.  
Para instalación con salida vertical es necesario codo. Para instalación con salida horizontal no es necesario codo. Ver ref. en respuestas.



## ASIENTO FIJO

	5168001 <b>BLANCO</b>	78,8		5168003 <b>AMARILLO</b>	78,8
	5168015 <b>ROSA</b>	78,8		5168011 <b>AZUL</b>	78,8

## ARO

	5168101 <b>BLANCO</b>	65,5		5168103 <b>AMARILLO</b>	65,5
	5168115 <b>ROSA</b>	65,5		5168111 <b>AZUL</b>	65,5

 **CONJUNTO INODORO COMPLETO\*** **237,5**

Nota: \*El conjunto inodoro completo está formado por: inodoro para tanque alto BTW y aro. BTW: pegado a la pared.



## + REPUESTOS Y ACCESORIOS €/u

53720 Codo curvo para inodoro salida vertical (para adaptar a distancia a pared de 90 mm). Varilla no incluida. **17,2**



col.  
**Blue**

# Blue



10060	<b>LAVABO</b>	16,2	18	158,0
-------	---------------	------	----	-------

**64 x 55 cm**  
Sin rebosadero y con juego de fijación. Instalación mural. Posibilidad de instalación con grifería Blue. Combinable con accesorios Trendly Hotels adaptados a serie Blue. Ver p. 300.

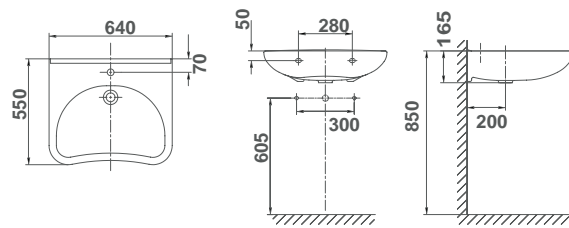

39300	<b>MONOMANDO DE LAVABO</b>			93,0
-------	----------------------------	--	--	------

Maneta gerontológica. Enlaces de alimentación flexible de 3/8".



10062	<b>INODORO PARA TANQUE BAJO</b>	28	9	342,0
-------	---------------------------------	----	---	-------

**71,5 x 36 cm** Altura 48 cm  
Salida dual.  
La cota de instalación, distancia a pared, salida vertical es de 21 cm Ø 11 cm. La cota de instalación, distancia a pared, salida horizontal es de 27 cm Ø 11 cm. Combinable con accesorios Trendly Hotels adaptados a serie Blue. Ver p. 300.

10068	<b>TANQUE BAJO CON TAPA</b>	14	40	151,0
-------	-----------------------------	----	----	-------

Alimentación inferior izquierda.

51485	<b>ASIENTO FIJO</b>			83,5
-------	---------------------	--	--	------

	<b>CONJUNTO INODORO COMPLETO*</b>			576,5
--	-----------------------------------	--	--	-------

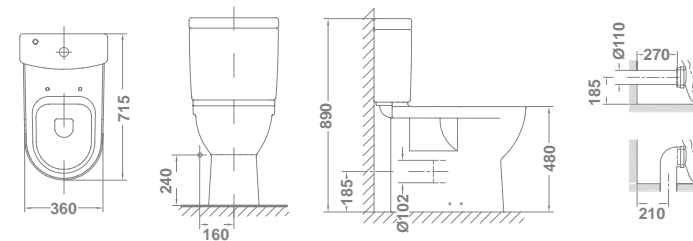

	<b>REPUESTOS Y ACCESORIOS</b>			€/u
--	-------------------------------	--	--	-----

53279	Juego de fijación lavabo Blue.			3,3
53711	Codo desagüe inodoro salida vertical 90° Blue.			30,4

# Blue suspendido



		€/u
10063	<b>INODORO SUSPENDIDO</b>	269,0
	70 x 36 cm Con salida horizontal.	
51486	<b>ARO INODORO</b>	54,5
53712	<b>TUBO DE ALIMENTACIÓN 40 CM</b>	17,6

	<b>CONJUNTO INODORO COMPLETO*</b>	323,5
--	-----------------------------------	-------

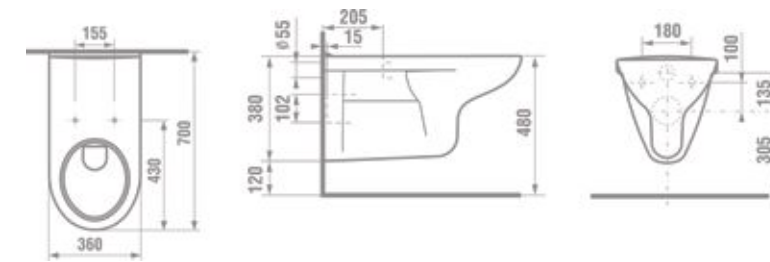

		€/u
55483	<b>WC FULL FRAME EON</b>	244,0

Sistema de instalación para inodoro suspendido en pared ligera. Descarga de 6/3L, 4,5/3L y 4/2L. Accesorios de instalación incluidos. Profundidad mínima: 108/125 mm (DN90/DN100). Codo ø90 o 110 mm

5056400	<b>PULSADOR EON 3 ANTIVANDÁLICO</b>	171,0
---------	-------------------------------------	-------

Acero inoxidable.

	<b>CONJUNTO COMPLETO**</b>	738,5
--	----------------------------	-------

Otras posibilidades de instalación en páginas 140 - 145.

**Nota:** \*El conjunto inodoro completo está formado por: inodoro para tanque bajo, tanque completo y asiento fijo. Todas las piezas de la colección Blue y movilidad reducida se suministran en caja.

**Nota:** \*El conjunto inodoro completo está formado por: inodoro suspendido y aro inodoro. \*\* El conjunto completo está formado por: inodoro suspendido, aro, WC Full Frame Eon y Pulsador Eon 3 Antivandálico

# Asientos

colecciones descatalogadas

51260 ASIENTO FIJO  
**GALA 2000** €/u 128,3

51340 ASIENTO FIJO  
**DIANA** €/u 63,5

51220 ASIENTO FIJO  
**AUREA** €/u 99,5

51450 ASIENTO FIJO  
**BACARA DM lacado** €/u 97,5  
Opciones color Blanco Pérgamo 107,5

51300 ASIENTO FIJO  
**NOSTALGIA** (Madera lacada blanco) €/u 131,2

51423 ASIENTO FIJO  
**MARINA** Opciones color Blanco Pérgamo €/u 66,4 73,4

51422 ASIENTO CON CAÍDA AMORTIGUADA  
**MARINA** €/u 115,3

51420 ASIENTO FIJO  
**MARINA** (Modelo anterior a 2007) Opciones color Blanco Pérgamo\* €/u 92,1 98,2

\*(En venta hasta fin de existencias)

51530 ASIENTO FIJO EN ASA BIMATERIAL  
**ARQ.** €/u 89,4

\*(En venta hasta fin de existencias)

51580 ASIENTO FIJO  
**UNIVERSAL** €/u 93,6

51570 ASIENTO CON CAÍDA AMORTIGUADA  
**UNIVERSAL** €/u 148,2

51590 TAPA PARA BIDÉ  
**UNIVERSAL** €/u 91,4

\*(En venta hasta fin de existencias)







51234 ASIENTO FIJO  
**JAZZ** €/u 56,8

51228 ASIENTO CON CAÍDA AMORTIGUADA  
**JAZZ** €/u 90,3

Nota: Colores a consultar.

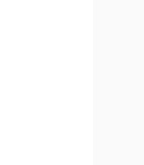
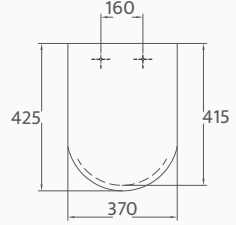
# Asientos

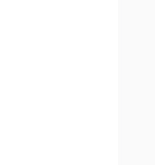
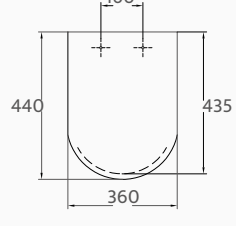
colecciones descatalogadas

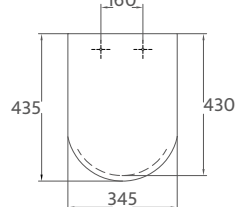
		€/u
	51282 ASIENTO FIJO <b>LOA</b>	67,1
	51281 ASIENTO CON CAÍDA AMORTIGUADA <b>LOA</b>	115,3
	51280 ASIENTO EXTRAÍBLE <b>LOA</b> *(En venta hasta fin de existencias)	73,2
		
	51514 ASIENTO FIJO <b>METROPOL</b>	58,8
	51515 ASIENTO CON CAÍDA AMORTIGUADA <b>METROPOL</b>	88,6
	51516 ASIENTO EXTRAÍBLE <b>METROPOL</b> *(En venta hasta fin de existencias)	59,8
		
	51272 ASIENTO FIJO <b>STREET</b>	45,4
	51275 ASIENTO CON CAÍDA AMORTIGUADA <b>STREET</b>	72,1
		

		€/u
	51370 ASIENTO FIJO <b>ELIA</b> Opciones color Pérgamo *(En venta hasta fin de existencias)	46,0
		
	E54116 ASIENTO FIJO <b>STYLO</b>	47,2
	E54117 ASIENTO CON CAÍDA AMORTIGUADA <b>STYLO</b>	88,1
		
	E54416 ASIENTO FIJO <b>DUNA</b> Opciones color Blanco Pérgamo	85,2 93,5
		
	E53516 ASIENTO FIJO <b>NEXO</b>	68,2
	E53517 ASIENTO CON CAÍDA AMORTIGUADA <b>NEXO</b>	103,4
		

		€/u
	51685 ASIENTO FIJO <b>KLEA</b>	82,1
	51686 ASIENTO CON CAÍDA AMORTIGUADA <b>KLEA</b>	145,8
		
	51688 TAPA BIDÉ <b>KLEA</b>	84,5
	51689 TAPA BIDÉ <b>KLEA</b> *(En venta hasta fin de existencias)	131,5
		
	51662 ASIENTO EXTRAÍBLE <b>EMMA</b> *(En venta hasta fin de existencias)	73,1
		
	51642 ASIENTO EXTRAÍBLE <b>EMMA SQUARE</b> *(En venta hasta fin de existencias)	99,0
		

# Sistemas y mecanismos



# Soportes Eon



55483 **WC FULL FRAME EON**   €/u **244,0**

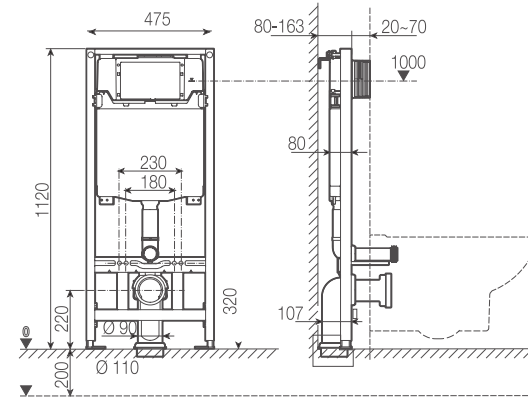

Sistema de instalación para inodoro suspendido en pared ligera. Descarga de 6/3L, 4,5/3L y 4/2L. Accesorios de instalación incluidos. Cisterna de 80 mm. Profundidad mínima para instalación: 107 mm (DN90/ DN100). Codo ø90 o 110 mm. Solo compatible con pulsadores Eon.

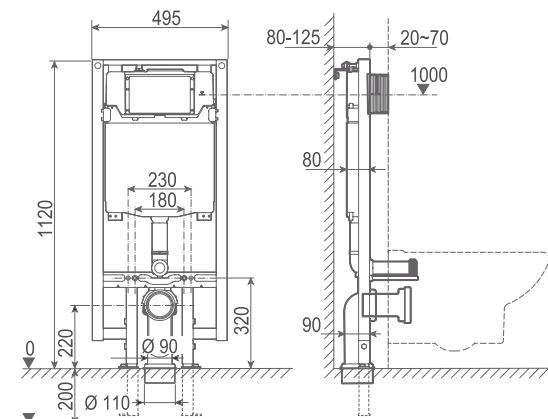

55480 **WC FULL FRAME EON COMPACT**   €/u **265,0**

Sistema de instalación para inodoro suspendido en pared ligera. Descarga de 6/3L, 4,5/3L y 4/2L. Accesorios de instalación incluidos. Cisterna de 80 mm. Profundidad mínima para instalación: 90/110 mm (DN90/ DN100). Codo ø90 o 110 mm. Solo compatible con pulsadores Eon.



55485 **WC FULL FRAME EON FREESTANDING**   €/u **305,0**

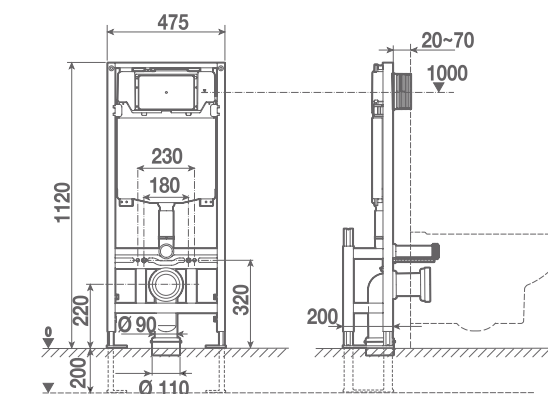

Sistema de instalación para inodoro suspendido autoportante. Descarga de 6/3L, 4,5/3L y 4/2L. Accesorios de instalación incluidos. Profundidad mínima para instalación: 200 mm. Codo ø90 o 110 mm. Solo compatible con pulsadores Eon.



55484 **WC FULL FRAME GALA INNOVA**   €/u **368,0**

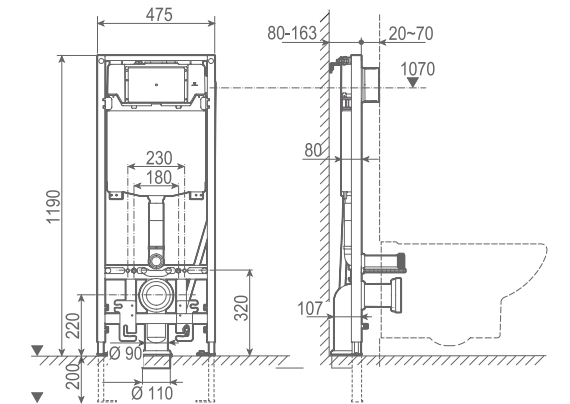

Sistema de instalación para inodoro suspendido Gala Innova. Incluye accesorios de instalación, flexo de alimentación y tubo corrugado para Shower toilets. Descarga 6/3L, 4,5/3L y 4/2L. Cisterna de 80 mm. Profundidad mínima para instalación: 107 mm (DN90/ DN100). Codo ø 90 o 110 mm. Sólo compatible con pulsadores Eon.



55481 **WC HALF FRAME EON COMPACT**   €/u **211,0**

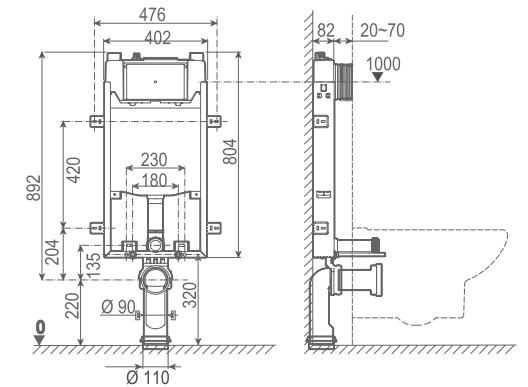

Sistema de instalación para inodoro suspendido en pared de obra. Descarga 6/3L, 4,5/3L y 4/2L. Accesorios de instalación incluidos. Profundidad mínima para instalación: 80/ 90 mm ( DN90/DN100 ) Codo ø 90 o 110 mm. Sólo compatible con pulsadores Eon.

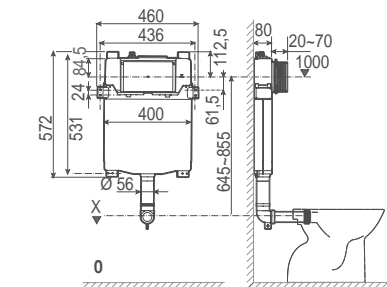

55482 **WC TANK EON COMPACT**   €/u **141,0**

Sistema de instalación para inodoro no suspendido en pared de obra y pared ligera. Descarga 6/3L, 4,5/3L y 4/2L. Accesorios de instalación incluidos. Profundidad mínima para instalación: 80 mm. Sólo compatible con pulsadores Eon.



55409 **BIDÉ FRAME EON COMPACT**   €/u **244,0**

Soporte para bidé. Accesorios de instalación incluidos. Profundidad mínima para instalación de 8 cm

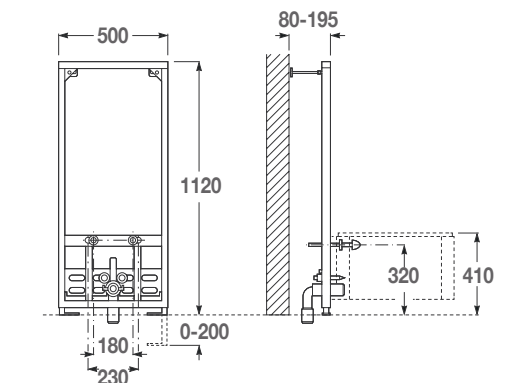

# Pulsadores Eon



## EON 8

50561 **PULSADOR DOBLE  
DESCARGA**

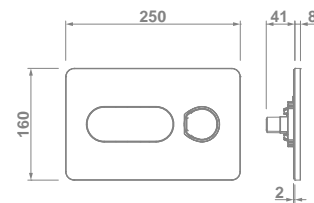

### OPCIONES COLOR



01 Blanco 45,8



69 Cromo brillo 53,0



70 Cromo mate  
(gris lacado) 53,0



## EON 9

50562 **PULSADOR DOBLE  
DESCARGA**

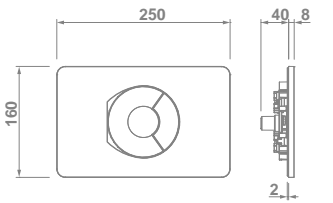

### OPCIONES COLOR



01 Blanco 45,8



69 Cromo brillo 53,0



70 Cromo mate  
(gris lacado) 53,0



# Pulsadores Eon



## EON 3

50563 **PULSADOR DOBLE  
DESCARGA**

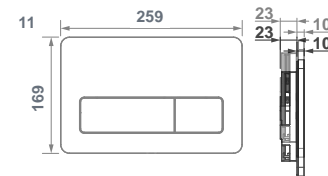

### OPCIONES COLOR



01 Blanco 40,0



02 Negro mate 48,5



69 Cromo brillo 48,5



70 Cromo mate (gris lacado) 48,5

## EON 3

5056400 **PULSADOR  
ANTIVANDÁLICO**  
Acero inoxidable.  
Pulsador simple.



€/u

171,0

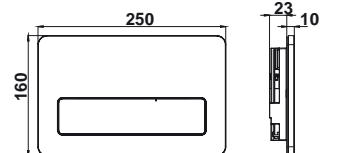

# Pulsadores Eon <sup>N</sup>



## EON 11

50567 **PULSADOR DOBLE  
DESCARGA**

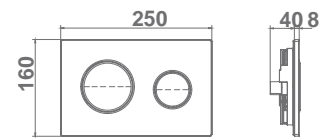

### OPCIONES COLOR



01 Blanco brillo 40,0



02 Negro mate 48,5



21 Blanco mate 48,5



69 Cromo brillo 48,5



70 Cromo mate  
(gris lacado) 48,5



**Nota:** Pulsadores Eon solo compatibles con soportes Eon

# Pulsadores Eon



## EON 3 ELECTRÓNICA

50566 **PULSADOR ELECTRÓNICO DE DOBLE DESCARGA**   €/u **402,0**

Autoflush. Descarga automática después de cada uso.



Sólo compatible con soportes EON

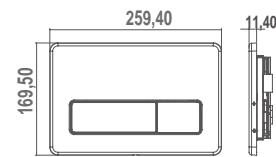

## SLOT

50568 **PULSADOR ELECTRÓNICO DE DOBLE DESCARGA**   €/u **237,0**

Touchless.



Sólo compatible con soportes EON

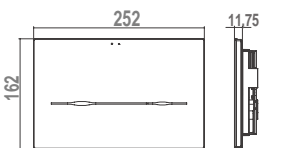

# Soporte Stride



55486 **WC FULL FRAME STRIDE** € / u 185,0

Sistema de instalación para inodoro suspendido en pared ligera.  
Descarga 6/3L, 4,5/3L y 4/2L  
Accesorios de instalación incluidos.  
Cisterna de 80mm. Profundidad mínima para instalación 107mm (DN90/DN100). Codo Ø90 o 110mm. Sólo compatible con pulsadores ST

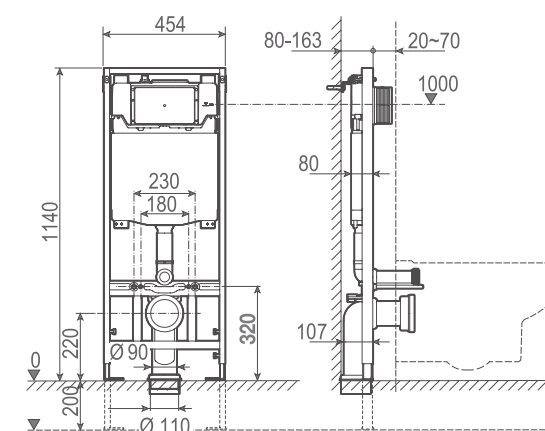

# Pulsadores Stride



**ST2**

50569 **PULSADOR DOBLE DESCARGA**

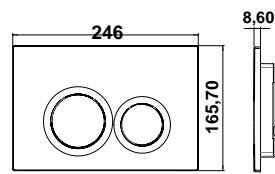

**OPCIONES COLOR**



01 Blanco 25,8



02 Negro mate 38,0



69 Cromo brillo 38,0



70 Cromo mate (gris lacado). 38,0



**ST4**

50570 **PULSADOR DOBLE DESCARGA**

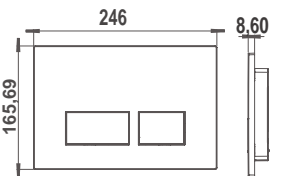

**OPCIONES COLOR**



01 Blanco 25,8



02 Negro mate 38,0





69 Cromo brillo 38,0



70 Cromo mate (gris lacado) 38,0

# Mecanismos encajados



50415 **MECANISMO UNIVERSAL ALIMENTACIÓN LATERAL**   €/u 21,0



Compatibles con Emma, Emma Square, Smart, Smart BTW, Nila alimentación lateral, Elia alimentación lateral, Street alimentación lateral, Jazz alimentación lateral, Metropol, Metropol BTW, Diana.  
Pedido mínimo caja expositor de 6 unidades.



50414 **MECANISMO UNIVERSAL ALIMENTACIÓN INFERIOR**   25,3

Compatibles con Emma, Emma Square, Smart, Smart BTW, Nila alimentación inferior, Elia alimentación inferior, Street alimentación inferior, Jazz alimentación inferior, Metropol, Metropol BTW, Marina, Loa, Bacara, Gala 2000, Florida, Nova Espacio.  
Pedido mínimo caja expositor de 6 unidades.



50413 **MECANISMO UNIVERSAL DE DESCARGA SIMPLE**   35,1

Compatibles con Emma, Emma Square, Smart, Smart BTW, Jazz, Street, Nila, Elia, Metropol, Metropol BTW, Marina, Loa, Bacara, Diana ø40 cm. Diana ø27 cm, Florida, Nova Espacio Pulsador de ø27 cm y ø40 cm incluido.  
Pedido mínimo caja expositor de 6 unidades.



50412 **MECANISMO UNIVERSAL DE DOBLE DESCARGA**   43,6

Compatibles con Emma, Emma Square, Smart, Smart BTW, Jazz, Street, Nila, Elia, Metropol, Metropol BTW, Marina, Loa, Bacara, Diana ø40 cm  
Pedido mínimo caja expositor de 6 unidades.



**lavabos**





# Lavabos

índice

172

## +DESIGN

- Hera
- Klea
- Emma Square
- Urban
- Soft
- Slim
- Albus
- Bowl
- Circle
- Casual

196

## ENCIMERA

- Óvalo
- Emma Square
- Circle
- Jara
- Nila
- Street square
- Nexus

200

## BAJO ENCIMERA

- Aída
- Nexus
- Egeo
- Flex

202

## SEMIEMPOTRAR

- Albus
- Circle
- Jara

204

## SOBRE MUEBLE

- Luc
- Mid
- Klea

208

## MURALES

- Albus
- Flex
- Casual

212

## LAVAMANOS

- Isla
- Aris
- Emma Square
- Smart
- Mid
- Albus



Slim galá/IP

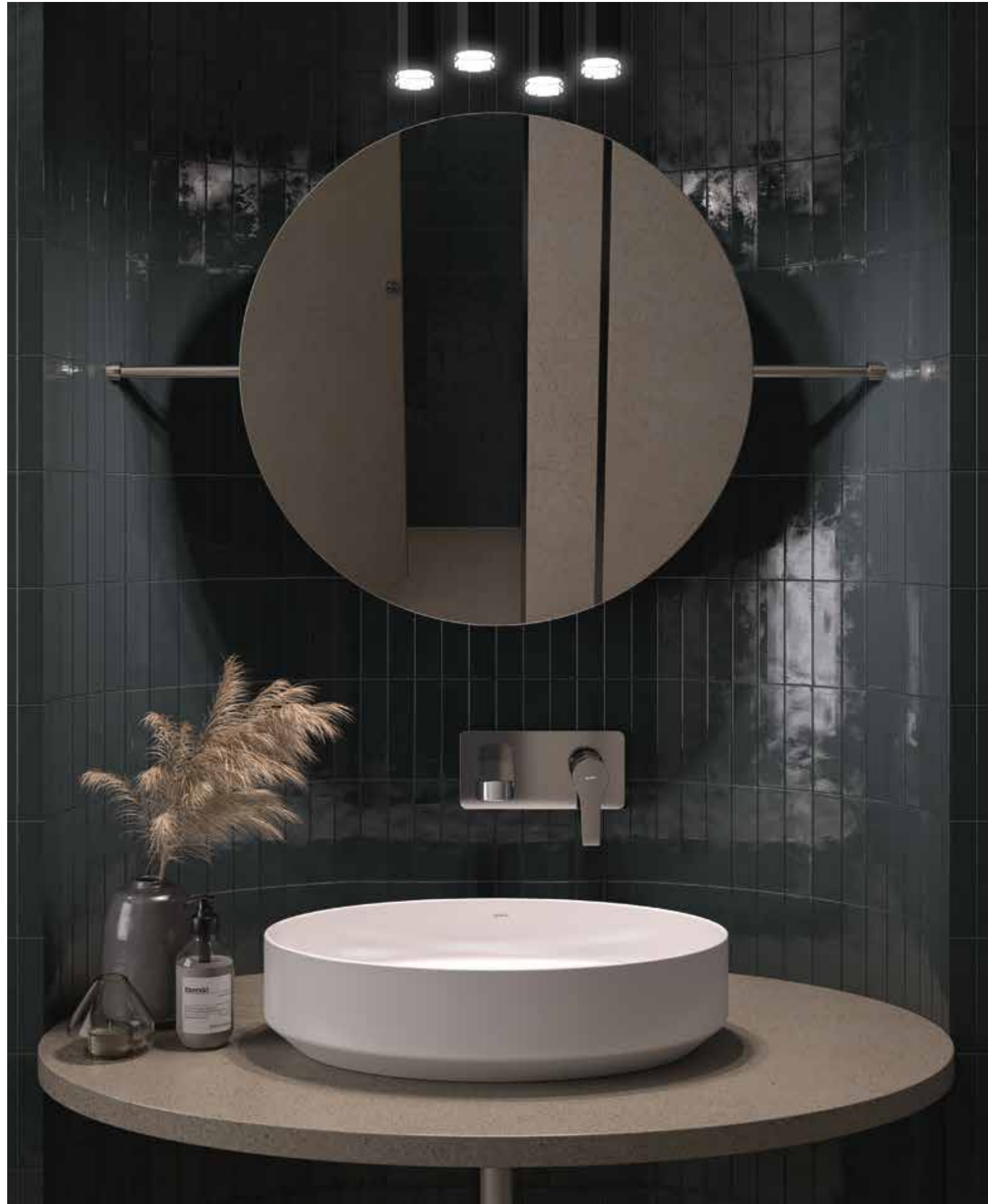

Hera



Klea galà/IP



Hera



# + Design

Lavabos



Hera **N**



€/u  
29243 **HERA ROUND**   108,0

**Ø38 cm**  
Lavabo HERA  
Sin rebosadero  
Sin orificio de grifería

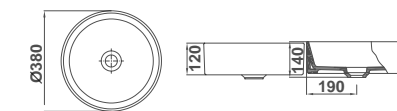

## OPCIONES COLOR



08 **NEGRO** 130,0



21 **BLANCO MATE** 130,0

## + OPCIONAL

48434 Desagüe fijo abierto con tapa cerámica

01 Blanco 36,0€ 08 Negro 45,0€ 21 Blanco Mate 45,0€

**Nota:** Los lavabos Hera Round se suministra en caja.



Hera **N**



29241 **HERA SQUARE** 38x38 cm   118,0 €/u  
Lavabo HERA SQ  
Sin rebosadero  
Sin orificio de grifería

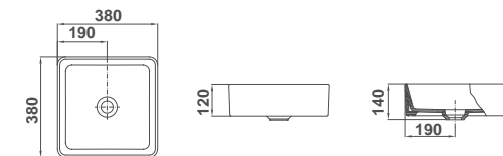

**OPCIONES COLOR**



08 **NEGRO** 142,0



21 **BLANCO MATE** 142,0

**+ OPCIONAL**

48434 Desagüe fijo abierto con tapa cerámica  
01 Blanco 36,0€ 08 Negro 45,0€ 21 Blanco Mate 45,0€

**Nota:** Los lavabos Hera Square se suministra en caja.



Hera **N**



29242 **HERA 60X38** 12 48 €/u  
**60x38 cm** 160,0

Lavabo HERA 60X38cm.  
Sin rebosadero  
Sin orificio de grifería

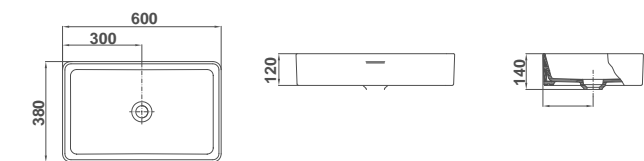

**OPCIONES COLOR**



08 **NEGRO** 192,0



21 **BLANCO MATE** 192,0

**+ OPCIONAL**

48434 Desagüe fijo abierto con tapa cerámica

01 Blanco 36,0€ 08 Negro 45,0€ 21 Blanco Mate 45,0€

**Nota:** Los lavabos Hera 60x38 se suministra en caja.



**Klea** *galáVIP*



33040 **KLEA** 90x40 cm  440,0 €/u  
Sin rebosadero. Plantilla de corte de 74x37 cm

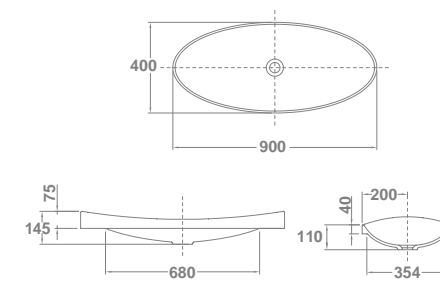

**OPCIONES COLOR**

08 **NEGRO** 510,0    21 **BLANCO MATE** 510,0

33050 **KLEA** 65x35 cm  330,0 €/u  
Sin rebosadero. Plantilla de corte de 53x32 cm

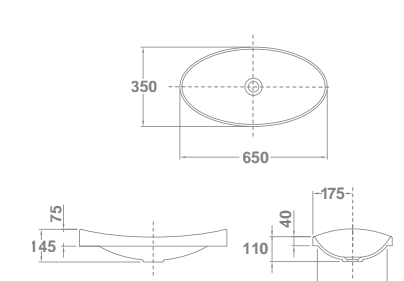

**OPCIONES COLOR**



08 **NEGRO** 380,0    21 **BLANCO MATE** 380,0

**Nota:** Los lavabos Klea se suministra en caja.



Emma Square galáVIP



27050 **EMMA SQUARE** 50x38 cm   224,0 €/u

Sin rebosadero. Sin orificio de grifería.

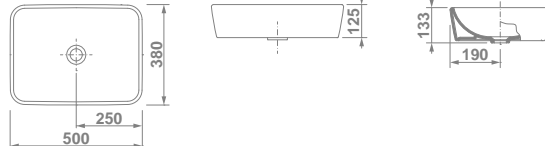

**OPCIONES COLOR**

- |   |                       |   |                             |
|---|-----------------------|---|-----------------------------|
|  | 08 <b>NEGRO</b> 256,0 |  | 21 <b>BLANCO MATE</b> 256,0 |
|---|-----------------------|---|-----------------------------|

Nota: Los lavabos Emma Square se suministra en caja.

## Urban



13040 **URBAN**  
Ø 45 cm  
Sin repisa y sin rebosadero.



€/u

115,5

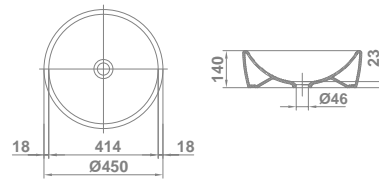

### OPCIONES COLOR



08 **NEGRO** 140,0



21 **BLANCO MATE** 140,0



Nota: Los lavabos Urban se suministran en caja.



Urban



13030 **URBAN**  
Ø 45 cm  
Con repisa y rebosadero.

10,5 32

115,5

€/u

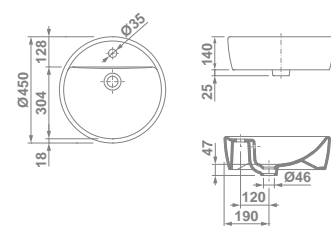

Soft



13050 **SOFT**  
57,5 x 45 cm  
Sin rebosadero.

11,8 32

153,5

€/u

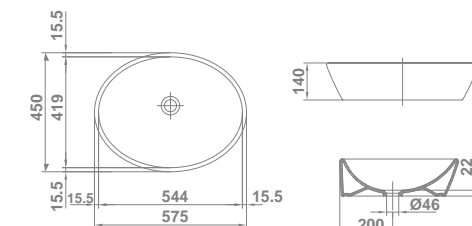

Slim *galáVIP*



29245 **SLIM**  
**60x37 cm**  
Sin rebosadero. Sin orificio de grifería

€ / u  
9,2 32 541,0

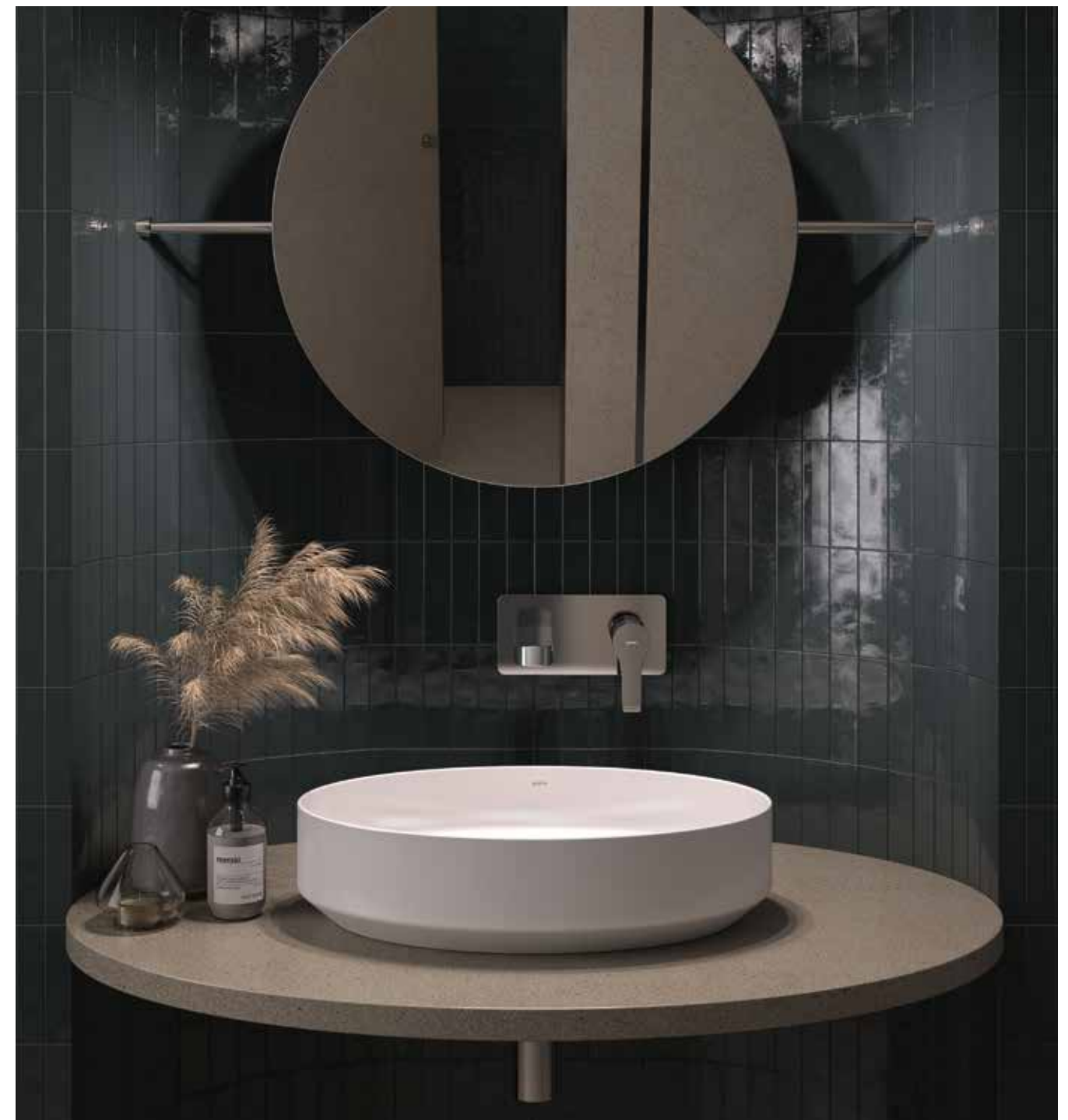
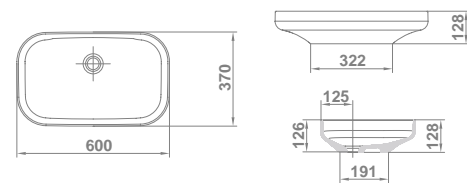

29240 **SLIM**  
**50x33 cm**  
Sin rebosadero. Sin orificio de grifería

€ / u  
6,2 32 469,0

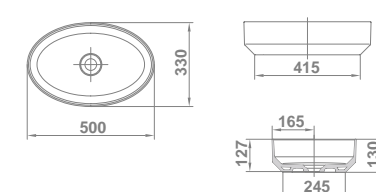

## Albus galáVIP



10207 **ALBUS**  
**101 x 45 cm**  
Con rebosadero. Con orificio de grifería.

€/u

27,5 21 257,5

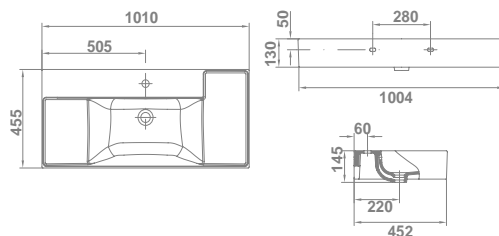

10211 **ALBUS**  
**81 x 45 cm**  
Con rebosadero. Con orificio de grifería.

€/u

23,5 21 216,5

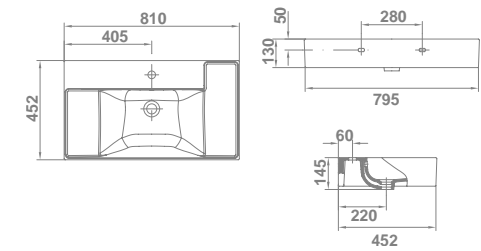

10213 **ALBUS**  
**61 x 45 cm**  
Con rebosadero. Con orificio de grifería.

€/u

17 32 192,5

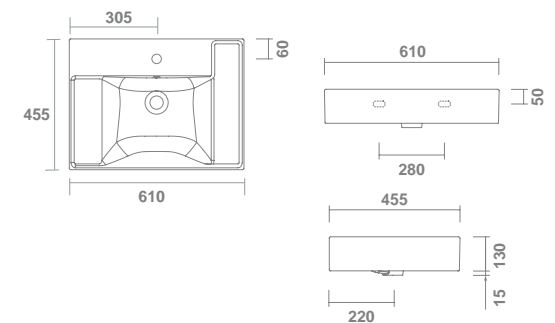



10215 **ALBUS**  
**60 x 45 cm** €/u  
15 32 192,5

Sin rebosadero. Con orificio de grifería. Esmaltado por los cuatro lados.

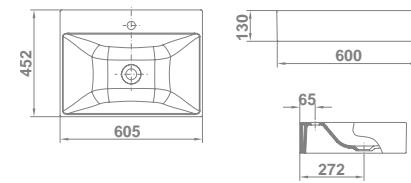

10219 **ALBUS**  
**45 x 45 cm** €/u  
12,5 32 162,5

Sin rebosadero. Con orificio de grifería. Esmaltado por los cuatro lados.

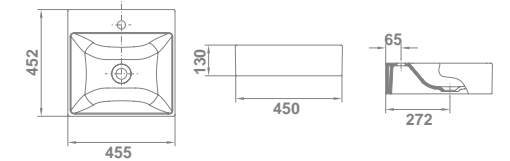

10217 **ALBUS**  
**60 x 45 cm** €/u  
16 32 192,5

Sin rebosadero. Sin orificio de grifería. Esmaltado por los cuatro lados.

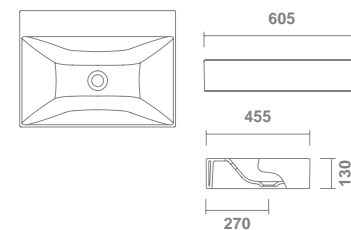

10221 **ALBUS**  
**45 x 45 cm** €/u  
12,5 32 162,5

Sin rebosadero. Sin orificio de grifería. Esmaltado por los cuatro lados.

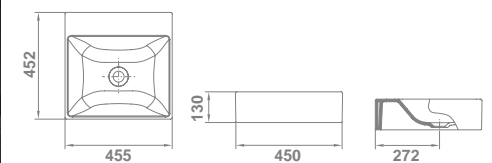

Bowl



10041 **BOWL**  
Ø 41 cm  
Con rebosadero.

€/u  
7 40 114,0

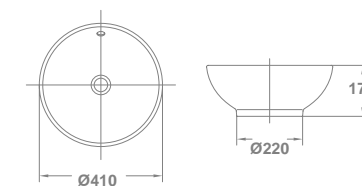

## Circle



04330 **CIRCLE**  
Ø 39,5 cm



7,6



48

€/u

214,0

Sin rebosadero. Sin orificio de grifería.  
Posibilidad de instalación sobre-  
encimera, encimera o semiempotrar.  
Plantilla de corte de Ø 31,2 cm para  
instalación sobre-encimera.

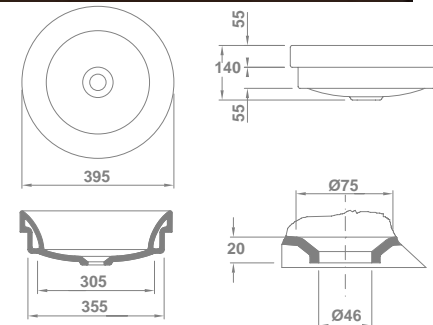

## Casual



13010 **CASUAL**  
80x47,5 cm



22,4



18

€/u

233,0

Sin rebosadero y con juego de  
fijación. Posibilidad de instalación  
sobre-encimera o mural.

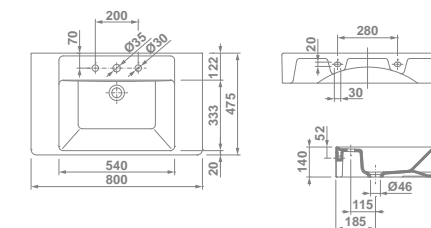

13020 **CASUAL**  
60x47,5 cm



17,7



32

€/u

216,0

Sin rebosadero y con juego de  
fijación. Posibilidad de instalación  
sobre-encimera o mural.

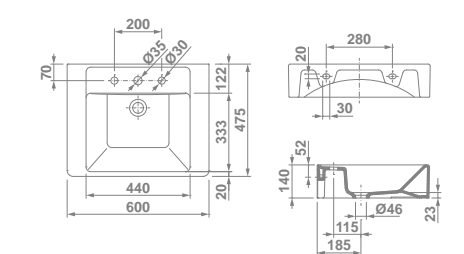

# Encimera

Lavabos





04320 **ÓVALO**  
63,5x39 cm  11,3  32 **246,0** €/u

Sin rebosadero. Sin orificio de grifería. Plantilla de corte de 61,2x36,2 cm

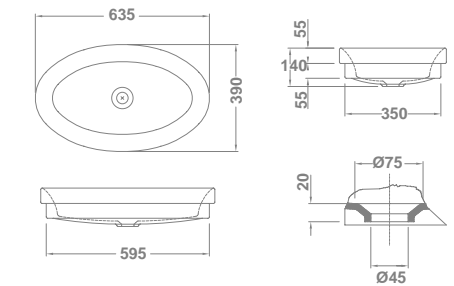
En venta hasta fin de existencias



04330 **CIRCLE**  
Ø 39,5 cm  7,6  48 **214,0** €/u

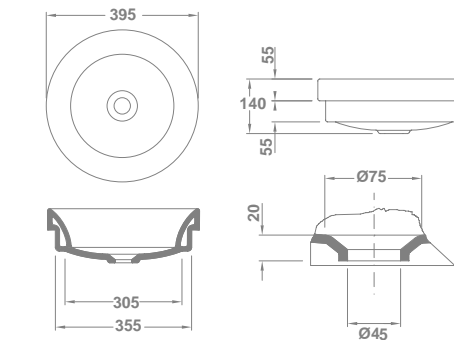

Sin rebosadero. Sin orificio de grifería. Posibilidad de instalación de encimera, sobre encimera o semiempotrar. Plantilla de corte de Ø 36 cm para instalación de encimera o semiempotrar.



27060 **EMMA SQUARE**  
55x42 cm  12  32 **169,0** €/u

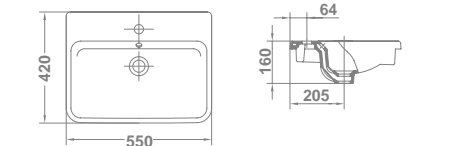

Con rebosadero. Plantilla de corte de 50,5 x 37,5 cm

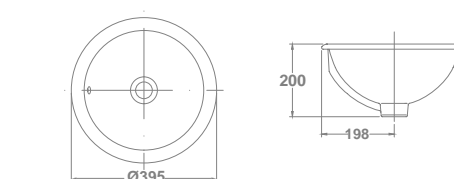

04220 **JARA**  
Ø 39,5 cm  5,1  48 **145,0** €/u

Con rebosadero. Sin orificio de grifería. Posibilidad de instalación de encimera o semiempotrar. Plantilla de corte de Ø 37 cm para instalación de encimera o semiempotrar.



17060 **NILA**  
56,5x47 cm  14,8  40 **83,9** €/u

Con rebosadero. Plantilla de corte de 53,5 x 44 cm

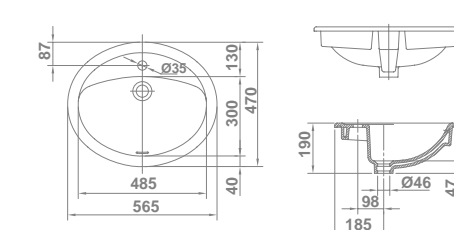

Nota: Los lavabos de encimera se suministran en caja.

Street Square



- €/u
- STREET SQUARE**  
Con rebosadero. Instalación de encimera pegado a pared.
- 05035 **60x45 cm** **102,0**  
Plantilla de corte de 53,6 x 41,8 cm
- 05045 **55x45 cm** **92,0**  
Plantilla de corte de 48,7 x 41,8 cm

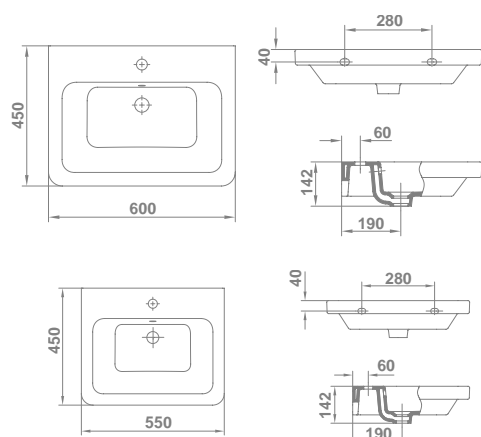

Nexus



- €/u
- 04160 **NEXUS** **113,5**  
**56x40 cm**  
Con rebosadero. Sin orificio de grifería. Posibilidad de instalación de encimera o bajo encimera. Plantilla de corte de 52,5 x 35,8 cm para instalación de encimera.

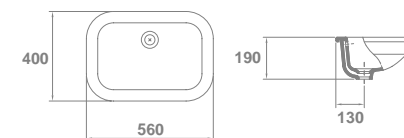



# Bajo encimera

Lavabos



04070 **AÍDA**  
**54,5x43 cm**  
 Con rebosadero y juego de fijación. Plantilla de corte de 46,5 x 35 cm

€/u

9 32 143,5

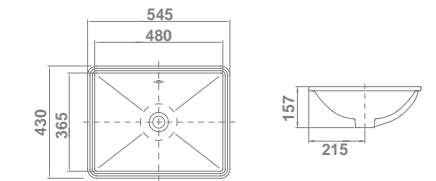

04160 **NEXUS**  
**56x40 cm**  
 Con rebosadero. Sin orificio de grifería. Posibilidad de instalación: bajo encimera o encimera. Plantilla de corte de 46 x 29,5 cm para instalación bajo encimera.

€/u

10,3 32 113,5

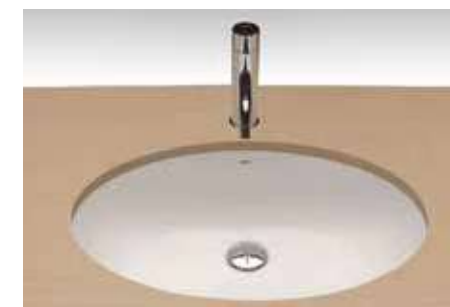
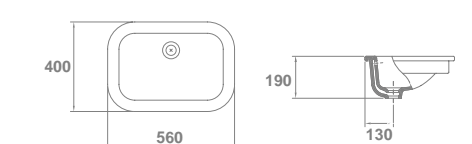

29220 **EGEO**  
**57x42 cm**  
 Con rebosadero y juego de fijación. Sin orificio de grifería. Plantilla de corte de 50 x 35,2 cm

€/u

7,3 32 95,0

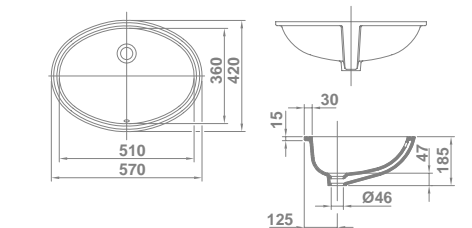

26020 **FLEX**  
**49x37 cm**  
 Con rebosadero y juego de fijación. Sin orificio de grifería. Plantilla de corte de 42,5 x 30,5 cm

€/u

6,9 32 123,0

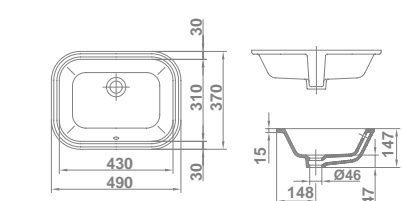

Nota: Los lavabos de bajo encimera se suministran en caja.

# Semiempotrar

Lavabos



10225 **ALBUS**  
gala/FP **47,5 cm** €15 32 €162,5  
Con rebosadero. Con orificio de grifería.

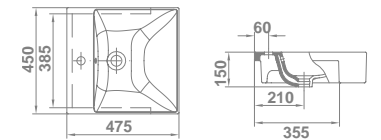

04330 **CIRCLE**  
**Ø 39,5 cm** €7,6 48 €214,0  
Sin rebosadero. Sin orificio de grifería. Posibilidad de instalación de semiempotrar, de encimera o sobre-encimera. Plantilla de corte de Ø 36 cm para instalación de semiempotrar o de encimera.

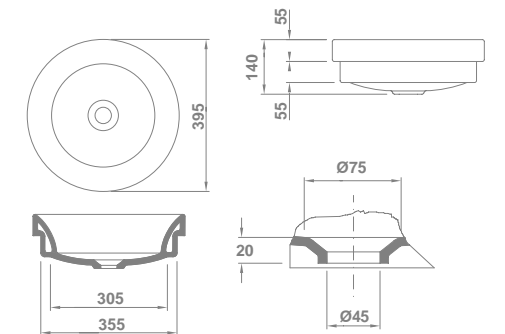

04220 **JARA**  
**Ø 39,5 cm** €5,1 48 €145,0  
Con rebosadero. Sin orificio de grifería. Posibilidad de instalación de semiempotrar o de encimera. Plantilla de corte de Ø 37 cm

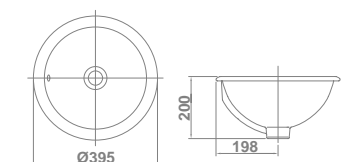

Nota: Los lavabos de semiempotrar se suministran en caja.

# Sobremueble

Lavabos

Luc 



		€/u
<b>LUC</b>		
Con rebosadero.		
10127	<b>121x46 cm</b>	  220,0
10126	<b>101x46 cm</b>	  190,0
10124	<b>81x46 cm</b>	  132,0
10123	<b>71x46 cm</b>	  120,0
10122	<b>61x46 cm</b>	  100,0

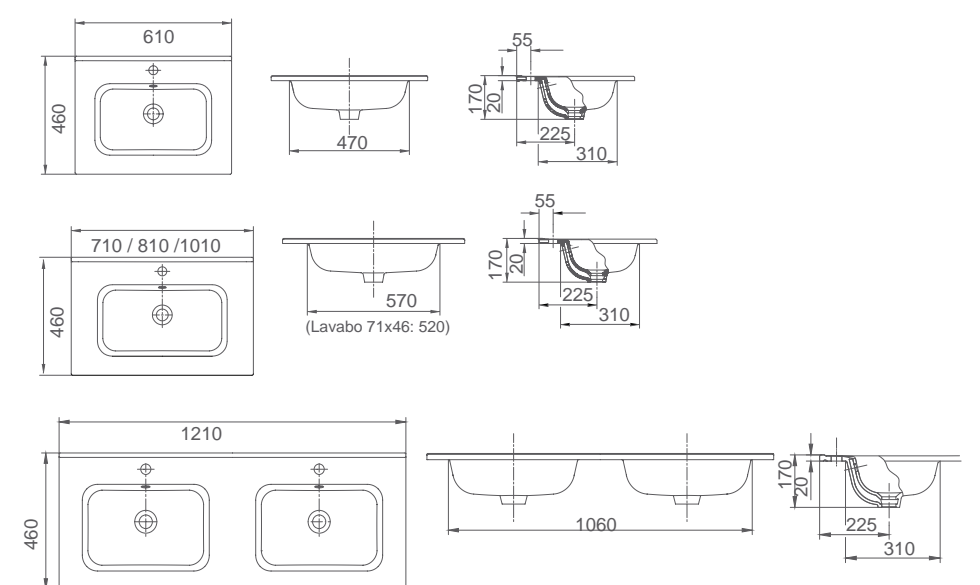

Nota: Los lavabos de sobremueble se suministran en caja.

## Mid



40090 **MID ASIMÉTRICO**  
**91x46 cm**  
 Con rebosadero. €/u 143 12 168,0

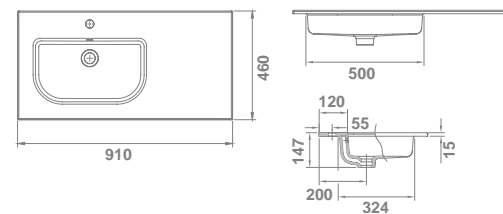

**MID**  
 Con rebosadero. €/u  
 40060 **101x46 cm** 30 12 188,5  
 40065 **81x46 cm** 28 18 146,5

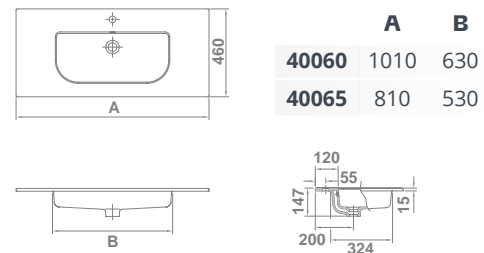

## Klea galá/IP



**KLEA**  
 Con rebosadero. €/u  
 33070 **101x46 cm** 16 12 203,0  
 33075 **81x46 cm** 13,5 18 162,5  
 33080 **61x46 cm** 10,8 32 135,0

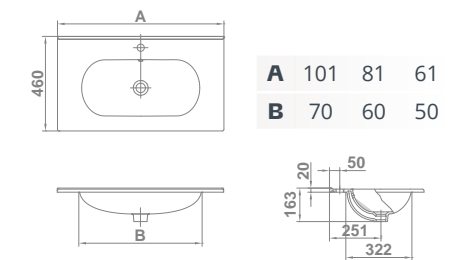

# Murales

Lavabos



Albus galá/IP



	€/u		
<b>ALBUS</b>			
Con rebosadero y juego de fijación.			
10208	<b>101x45 cm</b>		256,5
10212	<b>81x45 cm</b>		216,5
10214	<b>61x45 cm</b>		192,5



Nota: Los lavabos murales se suministran en caja,

## Flex

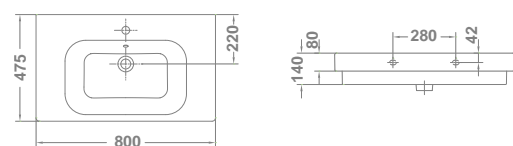

26030 **FLEX**  
**80x47,5 cm**  
 Con rebosadero y juego de fijación.

28,1 18 274,0



### + REPUESTOS Y ACCESORIOS

53511 Embellecedor de rebosadero para lavabos Flex. 3,9

## Casual



**CASUAL**  
 Sin rebosadero y juego de fijación.  
 Posibilidad de instalación mural  
 o sobre-encimera.

13010 **80x47,5 cm** 22,4 18 233,0

13020 **60x47,5 cm** 17,7 32 216,0

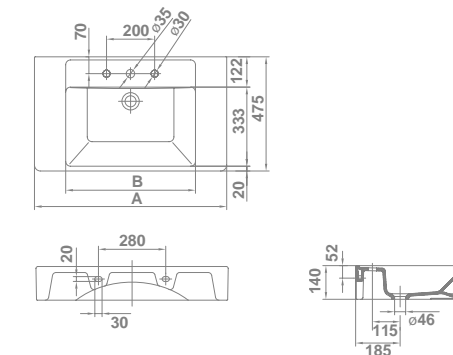

# lavamanos

Lavabos



## Isla



04410 **ISLA** €/u  
**Ø 39,5 cm** 10,8 32 140,0  
 Con rebosadero y juego de fijación.  
 Instalación mural en rincón.

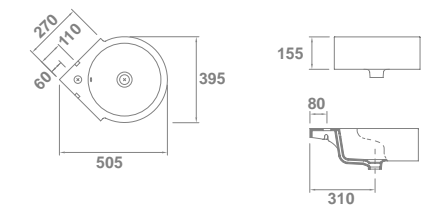

## Aris



47010 **ARIS** €/u  
**40x40 cm** 10,4 24 54,5  
 Con rebosadero y juego de fijación.  
 Posibilidad de instalación con pedestal,  
 semipedestal o mural.

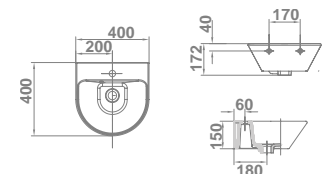

### + REPUESTOS Y ACCESORIOS

	€/u
53280 Juego de fijación lavamanos.	5,6

**Nota:** Los lavamanos se suministra en caja.

## Emma Square galáVIP



€/u  
27075 **EMMA SQUARE**   **48x37,5 cm** 163,0

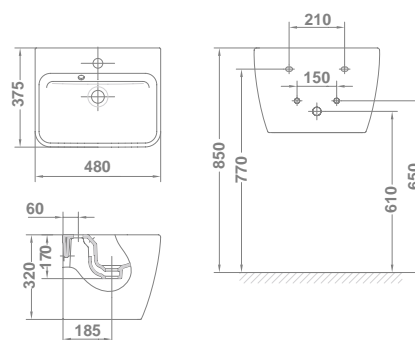

Con pedestal integrado, rebosadero y juego de fijación. Instalación mural.

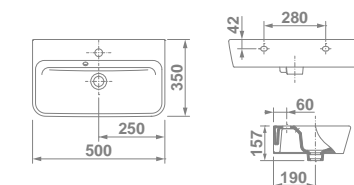

€/u  
27080 **EMMA SQUARE**   **50x35 cm** 113,0

Con rebosadero y juego de fijación. Posibilidad de instalación mural o sobre-encimera.



€/u  
27095 **EMMA SQUARE**   **50x25 cm** 108,0

Con rebosadero y juego de fijación. Posibilidad de instalación mural o sobre-encimera.

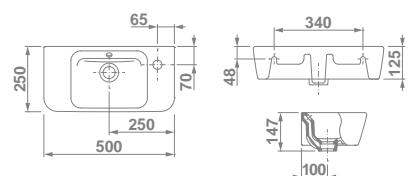

€/u  
27085 **EMMA SQUARE**   **42x32 cm** 109,0

Con rebosadero y juego de fijación. Posibilidad de instalación mural o sobre-encimera.

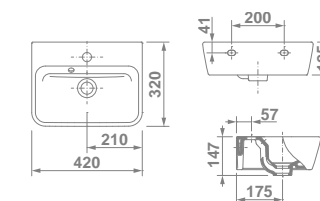

### + REPUESTOS Y ACCESORIOS

	€/u
53511 Embellecedor de rebosadero para lavabos Emma Square.	3,9
53280 Juego de fijación lavamanos.	5,6

**Nota:** Los lavabos Emma Square se suministran con embellecedor para rebosadero. Los lavamanos se suministra en caja.



# lavamanos

lavabos

## Smart



25090 **SMART**  
**45x36 cm** €/u  
11 24 71,5  
Con rebosadero y juego de fijación.  
Instalación mural.

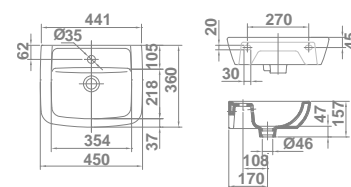

## Albus



10227 **ALBUS**  
**40x23 cm** €/u  
73 96 82,0  
Sin rebosadero. Con juego de fijación.

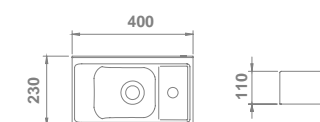

## Mid



40080 **MID**  
**45x45 cm** €/u  
13 24 98,0

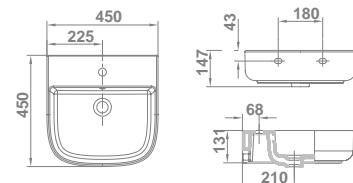

### + REPUESTOS Y ACCESORIOS

53280 Juego de fijación lavamanos. €/u 5,6

**muebles**  
de baño





# muebles

índice

222

SHONA MODULAR

230

DANE MODULAR <sup>N</sup>

238

SHONA

244

DANE <sup>N</sup>

248

DAILY

258

DAILY + ENCIMERA <sup>N</sup>

274

HANDY

280

MIK

284

ESPEJOS  
Y LUMINARIAS

296

ACCESORIOS  
MUEBLES

Indicamos a continuación referencia y precio correcto, para poder subsanar el error ante próximos pedidos.

*Pág. 246 Colección de Muebles Dane 1 cajón*

**gala**

Referencia	Blanco Mate	Negro Mate	Nogal	Precio
60 cm 1 cajón	7900721	7900708	7900785	450 €
80 cm 1 cajón	7900821	7900808	7900885	500 €
100 cm 1 cajón	7900921	7900908	7900985	575 €

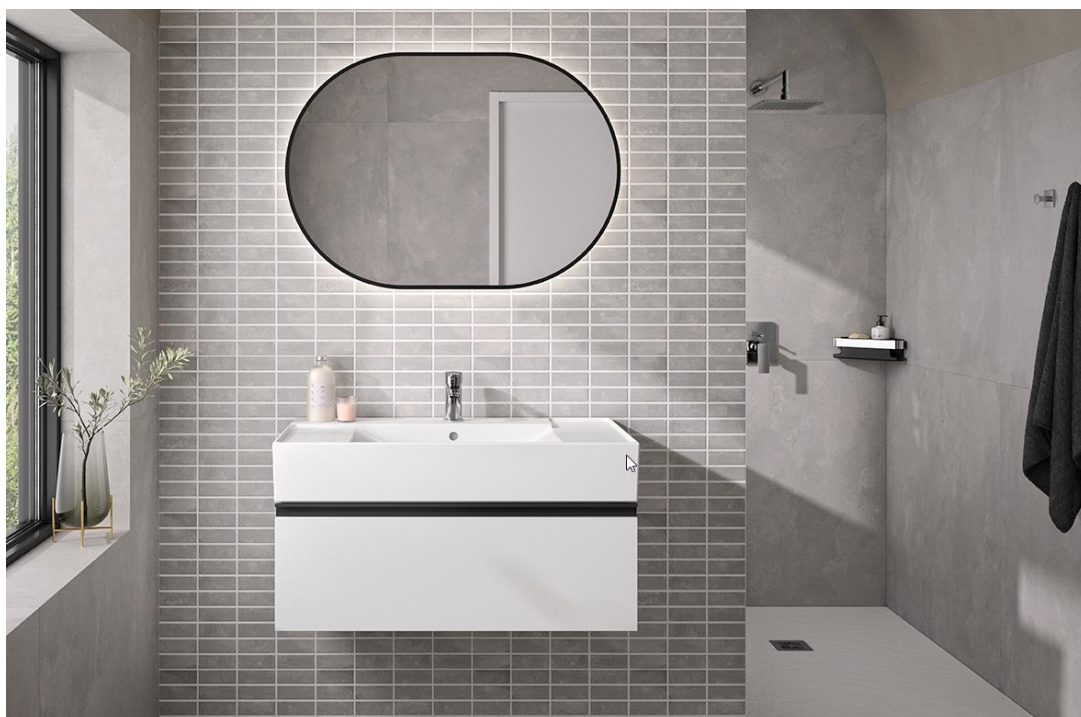



Col.  
**Shona**  
**modular**

# Shona Modular



# Shona Modular

muebles



# Shona Modular

COMBÍNALO PARA ADAPTARLO A TUS NECESIDADES

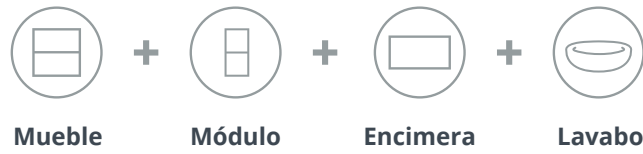

## SHONA MUEBLE

	BLANCO MATE	GALET MATE	€/u
<b>60 cm</b>			
2 cajones	3804821	3804831	<b>367,0</b>
<b>80 cm</b>			
2 cajones	3804921	3804931	<b>406,0</b>
<b>100 cm</b>			
2 cajones	3805021	3805031	<b>444,0</b>

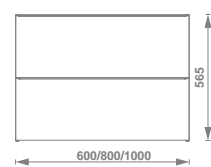

## SHONA ENCIMERA

	BLANCO MATE	GALET MATE	€/u
<b>60 cm</b>	3805521	3805531	<b>96,0</b>
<b>80 cm</b>	3805621	3805631	<b>109,0</b>
<b>100 cm</b>	3805721	3805731	<b>120,0</b>
<b>120 cm</b>	3805821	3805831	<b>140,0</b>
<b>140 cm</b>	3805921	3805931	<b>155,0</b>



## SHONA MÓDULO ABIERTO

	BLANCO MATE	GALET MATE	€/u
<b>20 cm</b>	3805421	3805431	<b>110,0</b>



## LAVABOS

### KLEA

	€/u
90x40 cm	33040 <b>440,0</b>
65x35 cm	33050 <b>330,0</b>
Acabados 90x40 cm	<b>510,0</b>
Acabados 65x35 cm	<b>380,0</b>
08 Negro	21 Blanco Mate

### URBAN

	€/u
Ø 45 cm	13040 <b>115,5</b>
Acabados	<b>140,0</b>
08 Negro	21 Blanco Mate

### HERA

	€/u
Ø 38 cm	29243 <b>108,0</b>
38X38 cm	29241 <b>118,0</b>
60X38 cm	29242 <b>160,0</b>
Acabados Ø 38 cm	<b>130,0</b>
Acabados 38X38 cm	<b>142,0</b>
Acabados 60X38 cm	<b>192,0</b>
08 Negro	21 Blanco Mate

### ALBUS

	€/u
60x45cm	10215 <b>192,5</b>
45x45 cm	10219 <b>162,5</b>

### EMMA SQ

	€/u
50x38 cm	27050 <b>224,0</b>
Acabados	<b>256,0</b>
08 Negro	21 Blanco Mate







Col.  
**Dane**  
**modular**

# Dane Modular <sup>N</sup>

muebles

**DIFERENTES MEDIDAS. DIFERENTES COMBINACIONES. DIFERENTES RESULTADOS**



**ELIGE MEDIDAS**



**ELIGE ACABADO**



**ELIGE EL MUEBLE A TU MEDIDA**



**ELIGE COMPOSICIÓN**



Escanea el código QR y elige la composición que más te guste



Soft Close



Extracción total



Guías Hettich



Cajón con organizador



# Dane Modular <sup>N</sup>

muebles

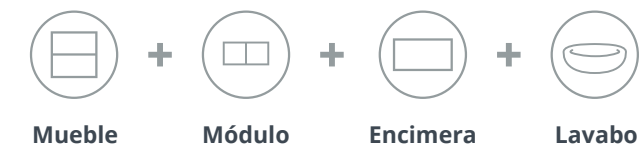

## DANE MUEBLE

	BLANCO MATE	NEGRO MATE	NOGAL	€/u
<b>60 cm</b>				
1 cajón	3806421	3806408	3806485	306,0
<b>80 cm</b>				
1 cajón	3806521	3806508	3806585	345,0
<b>100 cm</b>				
1 cajón	3806621	3806608	3806685	410,0

TIRADOR ACABADO NEGRO



## DANE ENCIMERA

	BLANCO MATE	NEGRO MATE	NOGAL	€/u
<b>60 cm</b>	3805521	3805508	3805585	96,0
<b>80 cm</b>	3805621	3805608	3805685	109,0
<b>100 cm</b>	3805721	3805708	3805785	120,0
<b>120 cm</b>	3805821	3805808	3805885	140,0
<b>140 cm</b>	3805921	3805908	3805985	155,0
<b>160 cm</b>	3806021	3806008	3806085	200,0
<b>180 cm</b>	3806721	3806708	3806785	220,0
<b>200 cm</b>	3806821	3806808	3806885	250,0



## DANE MÓDULO ABIERTO

	BLANCO MATE	NEGRO MATE	NOGAL	€/u
<b>60 cm</b>	3806321	3806308	3806385	150,0

## LAVABOS

### HERA



Acabados 130,0

08 Negro 21 Blanco Mate



Acabados 142,0

08 Negro 21 Blanco Mate

### KLEA



Acabados 90x40 cm 510,0

Acabados 65x35 cm 380,0

08 Negro 21 Blanco Mate

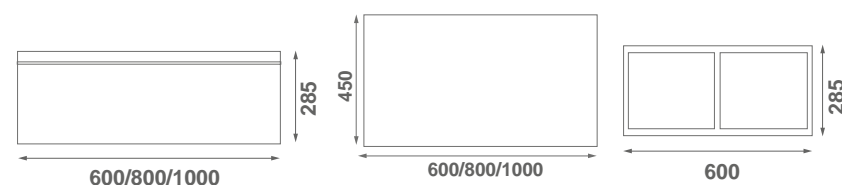



Col.  
**Shona**

# Shona

2 cajones



**SHONA**

		BLANCO MATE	GALET MATE	€/u
<b>60 cm</b>	Pack *	7918121	7918131	<b>602,0</b>
<b>2 cajones</b>	Conjunto (mueble + lavabo)	7896221	7896231	<b>475,0</b>
<b>80 cm</b>	Pack *	7918221	7918231	<b>655,0</b>
<b>2 cajones</b>	Conjunto (mueble + lavabo)	7896321	7896331	<b>519,0</b>
<b>100 cm</b>	Pack *	7918321	7918331	<b>785,0</b>
<b>2 cajones</b>	Conjunto (mueble + lavabo)	7896421	7896431	<b>642,0</b>

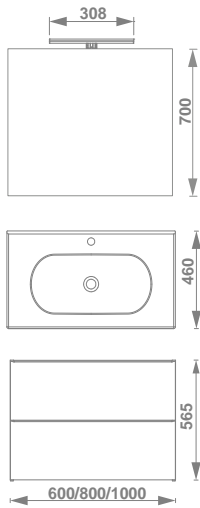

Soft Close



Extracción total



Guías Hettich

\* Pack: mueble+lavabo+espejo Only+luminaria Daily 30 LED 8W.

# Shona

3 cajones



Interiores en textura cuero

SHONA	BLANCO MATE	GALET MATE	€/u
<b>Columna 30x150x28 cm 2 puertas</b>	3804621	3804631	<b>288,0</b>
<b>SHONA</b>	BLANCO MATE	GALET MATE	€/u
<b>Alto 35x80x15 cm 1 puerta</b>	3804721	3804731	<b>210,0</b>

SHONA		BLANCO MATE	GALET MATE	€/u
<b>60 cm</b>	Pack *	7918521	7918531	<b>673,0</b>
<b>3 cajones</b>	Conjunto (mueble + lavabo)	7896621	7896631	<b>575,0</b>
<b>80 cm</b>	Pack *	7918621	7918631	<b>740,0</b>
<b>3 cajones</b>	Conjunto (mueble + lavabo)	7896721	7896731	<b>620,0</b>
<b>100 cm</b>	Pack *	7918721	7918731	<b>885,0</b>
<b>3 cajones</b>	Conjunto (mueble + lavabo)	7896821	7896831	<b>657,0</b>

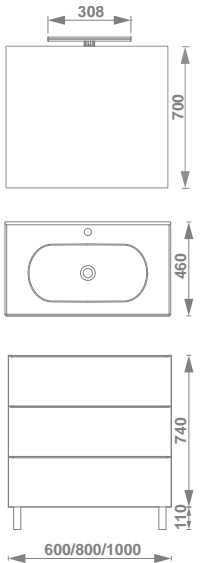

Cajones con extracción total

- Soft Close
- Extracción total
- Guías Hettich

\* Pack: mueble+lavabo+espejo Only+luminaria Daily 30 LED 8W.

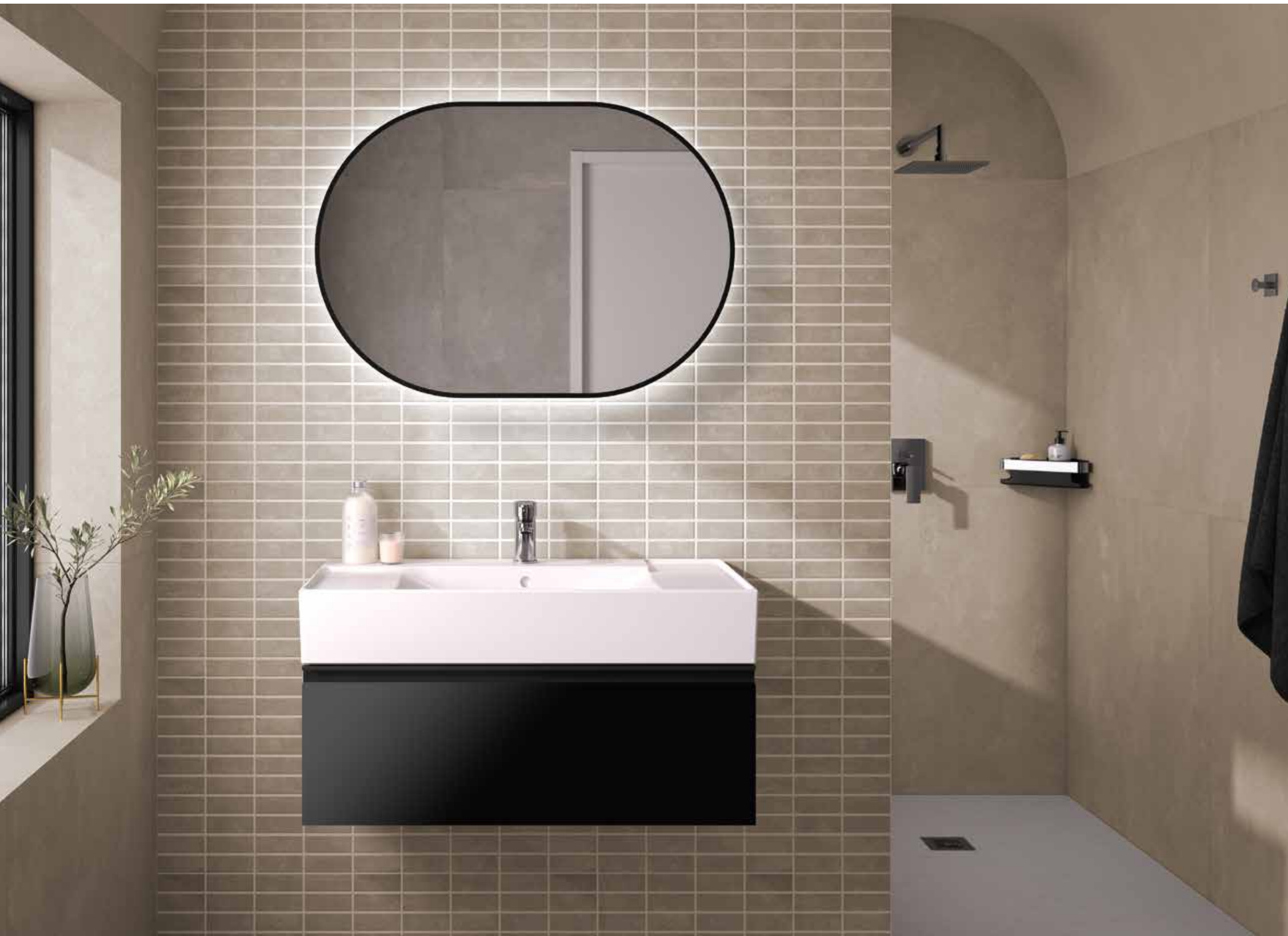

Col.  
**D a n e**



# Dane

mueble 1 cajón



DANE + LAVABO ALBUS	BLANCO MATE	NEGRO MATE	NOGAL	€/u
60 cm 1 cajón	7900721	7900708	7900785	350,0
80 cm 1 cajón	7900821	7900808	7900885	380,0
100 cm 1 cajón	7900921	7900908	7900985	440,0



Soft Close



Extracción total



Guías Hettich



Cajón con organizador

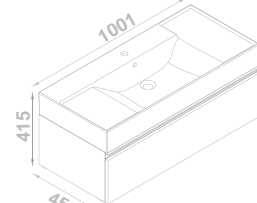
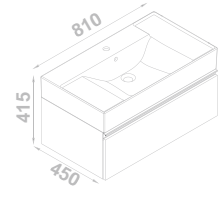
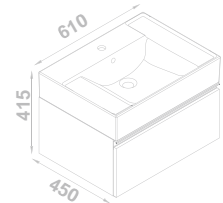

Cajón con extracción total y organizador interior.



Col.  
**D a i l y**

# Daily

2 cajones | 4 cajones



muebles

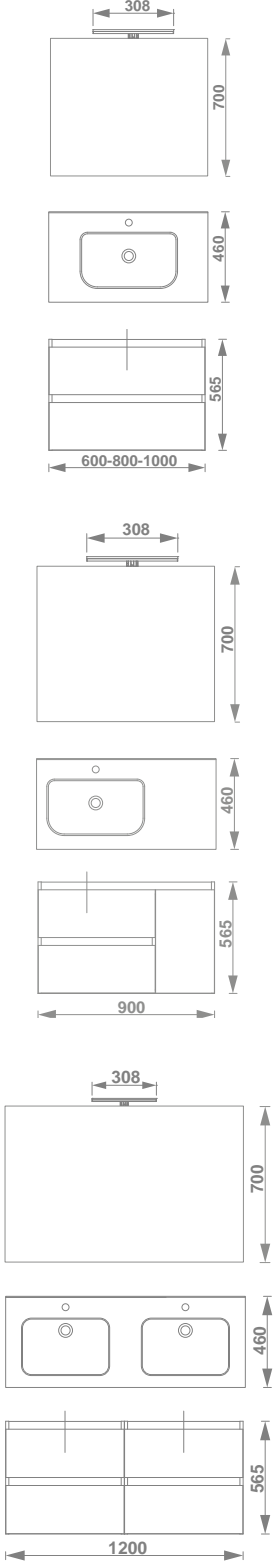

DAILY		BLANCO BRILLO	ANTRACITA BRILLO	GALET BRILLO	ROBLE RÚSTICO	€/u
<b>60 cm</b>	Pack *	7916901	7916984	7916930	7916974	<b>484,0</b>
<b>2 cajones</b>	Conjunto (mueble + lavabo).	7895001	7895084	7895030	7895074	<b>395,0</b>
<b>80 cm</b>	Pack *	7917001	7917084	7917030	7917074	<b>538,0</b>
<b>2 cajones</b>	Conjunto (mueble + lavabo).	7895101	7895184	7895130	7895174	<b>435,0</b>
<b>90 cm</b>	Pack *	7917101	7917184	7917130	7917174	<b>624,0</b>
<b>2 cajones + 1 puerta</b>	Conjunto (mueble + lavabo).	7895201	7895284	7895230	7895274	<b>521,0</b>
<b>100 cm</b>	Pack *	7917201	7917284	7917230	7917274	<b>635,0</b>
<b>2 cajones</b>	Conjunto (mueble + lavabo).	7895301	7895384	7895330	7895374	<b>533,0</b>
<b>120 cm</b>	Pack *	7917301	7917384	7917330	7917374	<b>968,0</b>
<b>4 cajones</b>	Conjunto (mueble + lavabo).	7895401	7895484	7895430	7895474	<b>855,0</b>



Soft Close



Guías Hettich



Cajón con organizador

\* Pack: mueble+lavabo+espejo Only+luminaria Daily 30 LED 8W.

# Daily

2 cajones



3 cajones



# Daily

3 cajones

muebles



Cajones en acabado textil coco

DAILY		BLANCO BRILLO	ANTRACITA BRILLO	GALET BRILLO	ROBLE RÚSTICO	€/u	
<b>80 cm</b>	Pack *	7917701	7917784	7917730	7917774	<b>608,0</b>	
<b>3 cajones</b>	Conjunto (mueble + lavabo)	7895801	7895884	7895830	7895874	<b>521,0</b>	
<b>100 cm</b>	Pack *	7917801	7917884	7917830	7917874	<b>720,0</b>	
<b>3 cajones</b>	Conjunto (mueble + lavabo)	7895901	7895984	7895930	7895974	<b>630,0</b>	



Soft Close



Guías Hettich



Cajón con organizador

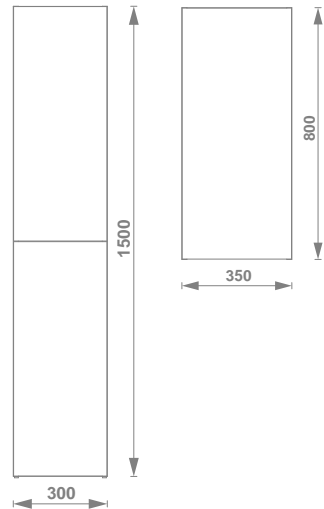
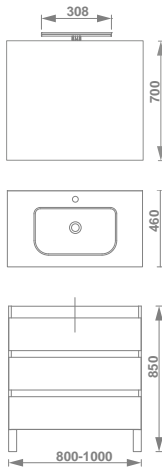

DAILY		BLANCO BRILLO	ANTRACITA BRILLO	GALET BRILLO	ROBLE RÚSTICO	€/u
<b>Columna 30x150x28 cm</b>	<b>2 puertas</b>	3804601	3804684	3804630	3804674	<b>288,0</b>

DAILY		BLANCO BRILLO	ANTRACITA BRILLO	GALET BRILLO	ROBLE RÚSTICO	€/u
<b>Alto 35x80x15 cm</b>	<b>1 puerta</b>	3804701	3804784	3804730	3804774	<b>210,0</b>

\* Pack: mueble+lavabo+espejo Only+luminaria Daily 30 LED 8W.

# Daily

1 cajón | 1 hueco

muebles



DAILY		BLANCO BRILLO	ANTRACITA BRILLO	GALET BRILLO	ROBLE RÚSTICO	€/u
60 cm	Pack *	7917401	7917484	7917430	7917474	490,0
1 cajón + 1 hueco	Conjunto (mueble + lavabo).	7895501	7895584	7895530	7895574	360,0
80 cm	Pack *	7917501	7917584	7917530	7917574	511,0
1 cajón + 1 hueco	Conjunto (mueble + lavabo).	7895601	7895684	7895630	7895674	409,0
100 cm	Pack *	7917601	7917684	7917630	7917674	624,0
1 cajón + 1 hueco	Conjunto (mueble + lavabo).	7895701	7895784	7895730	7895774	489,0

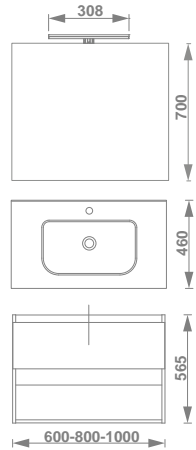

Soft Close



Guías Hettich



Cajón con organizador

\* Pack: mueble+lavabo+espejo Only+luminaria Daily 30 LED 8W.









Col.  
**Daily**  
**+ encimera**

# Daily + Urban N





mueble + encimera + lavabo Urban



muebles

	 + 			€/u	
	Mueble Lavabo blanco	BLANCO BRILLO	ROBLE RÚSTICO		Soft Close
<b>60 cm</b> <b>2 cajones</b>	Conjunto (mueble + lavabo)*	7898001	7898074	<b>501,0</b>	
<b>80 cm</b> <b>2 cajones</b>	Conjunto (mueble + lavabo)*	7898101	7898174	<b>545,0</b>	<b>Guías Hettich</b>
<b>100 cm</b> <b>2 cajones</b>	Conjunto (mueble + lavabo)*	7898201	7898274	<b>639,0</b>	
<b>120 cm</b> <b>4 cajones</b>	Conjunto (mueble + 2 lavabos)*	7898301	7898374	<b>1.083,0</b>	<b>Cajón con organizador</b>

\* Mueble Daily + encimera + lavabo Urban blanco

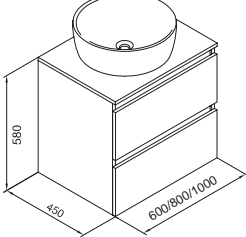
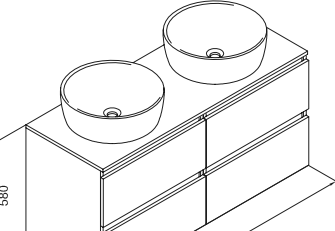
	 + 			€/u	
	Mueble Lavabo negro	BLANCO BRILLO	ROBLE RÚSTICO		
<b>60 cm</b> <b>2 cajones</b>	Conjunto (mueble + lavabo)*	7898701	7898774	<b>501,0</b>	
<b>80 cm</b> <b>2 cajones</b>	Conjunto (mueble + lavabo)*	7898801	7898874	<b>545,0</b>	
<b>100 cm</b> <b>2 cajones</b>	Conjunto (mueble + lavabo)*	7898901	7898974	<b>639,0</b>	
<b>120 cm</b> <b>4 cajones</b>	Conjunto (mueble + 2 lavabos)*	7899001	7899074	<b>1.083,0</b>	

\* Mueble Daily + encimera + lavabo Urban negro



# Daily + Urban <sup>N</sup>

mueble 1 cajón + 1 hueco + encimera + lavabo Urban



muebles

+   
Mueble Lavabo blanco

BLANCO BRILLO ROBLE RÚSTICO €/u

60 cm 1 cajón + 1 hueco	Conjunto (mueble + lavabo)*	7898401	7898474	457,0
80 cm 1 cajón + 1 hueco	Conjunto (mueble + lavabo)*	7898501	7898574	496,0
100 cm 1 cajón + 1 hueco	Conjunto (mueble + lavabo)*	7898601	7898674	593,0

Soft Close

Guías Hettich

Cajón con organizador

+   
Mueble Lavabo negro

BLANCO BRILLO ROBLE RÚSTICO €/u

60 cm 1 cajón + 1 hueco	Conjunto (mueble + lavabo)*	7899101	7899174	457,0
80 cm 1 cajón + 1 hueco	Conjunto (mueble + lavabo)*	7899201	7899274	496,0
100 cm 1 cajón + 1 hueco	Conjunto (mueble + lavabo)*	7899301	7899374	593,0

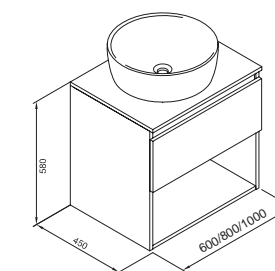

\* Mueble Daily + encimera + lavabo Urban blanco

\* Mueble Daily + encimera + lavabo Urban negro



# Daily + Hera <sup>N</sup>

mueble + encimera + lavabo Hera Round







muebles

	 + 			€/u
	Mueble Lavabo blanco	BLANCO BRILLO	ROBLE RÚSTICO	
<b>60 cm</b> 2 cajones	Conjunto (mueble + lavabo)*	7890001	7890074	<b>501,0</b>
<b>80 cm</b> 2 cajones	Conjunto (mueble + lavabo)*	7890101	7890174	<b>545,0</b>
<b>100 cm</b> 2 cajones	Conjunto (mueble + lavabo)*	7890201	7890274	<b>639,0</b>
<b>120 cm</b> 4 cajones	Conjunto (mueble + 2 lavabos)*	7890301	7890374	<b>1.083,0</b>

-  **Soft Close**
-  **Guías Hettich**
-  **Cajón con organizador**

\* Mueble Daily + encimera + lavabo Hera Round blanco

	 + 			€/u
	Mueble Lavabo negro	BLANCO BRILLO	ROBLE RÚSTICO	
<b>60 cm</b> 2 cajones	Conjunto (mueble + lavabo)*	7890701	7890774	<b>501,0</b>
<b>80 cm</b> 2 cajones	Conjunto (mueble + lavabo)*	7890801	7890874	<b>545,0</b>
<b>100 cm</b> 2 cajones	Conjunto (mueble + lavabo)*	7890901	7890974	<b>639,0</b>
<b>120 cm</b> 4 cajones	Conjunto (mueble + 2 lavabos)*	7891001	7891074	<b>1.083,0</b>

\* Mueble Daily + encimera + lavabo Hera Round negro

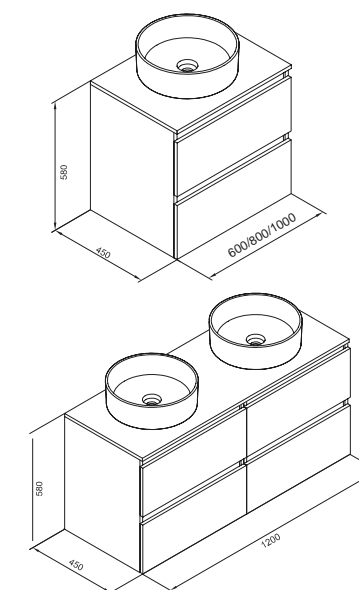

# Daily + Hera <sup>N</sup>

mueble 1 cajón + 1 hueco + encimera + lavabo Hera Round

muebles



	 + 			€/u	
	Mueble Lavabo blanco	BLANCO BRILLO	ROBLE RÚSTICO		Soft Close
60 cm 1 cajón + 1 hueco	Conjunto (mueble + lavabo)*	7890401	7890474	457,0	 Guías Hettich
80 cm 1 cajón + 1 hueco	Conjunto (mueble + lavabo)*	7890501	7890574	496,0	
100 cm 1 cajón + 1 hueco	Conjunto (mueble + lavabo)*	7890601	7890674	593,0	

 Cajón con organizador

	 + 			€/u	
	Mueble Lavabo negro	BLANCO BRILLO	ROBLE RÚSTICO		
60 cm 1 cajón + 1 hueco	Conjunto (mueble + lavabo)*	7891101	7891174	457,0	
80 cm 1 cajón + 1 hueco	Conjunto (mueble + lavabo)*	7891201	7891274	496,0	
100 cm 1 cajón + 1 hueco	Conjunto (mueble + lavabo)*	7891301	7891374	593,0	

\* Mueble Daily + encimera + lavabo Hera Round blanco

\* Mueble Daily + encimera + lavabo Hera Round negro

# Daily + Hera N

mueble + encimera + lavabo Hera Square



muebles

	 + 			€/u	
	Mueble Lavabo blanco	BLANCO BRILLO	ROBLE RÚSTICO		
<b>60 cm</b> 2 cajones	Conjunto (mueble + lavabo)*	7891401	7891474	<b>501,0</b>	 Soft Close   Guías Hettich   Cajón con organizador
<b>80 cm</b> 2 cajones	Conjunto (mueble + lavabo)*	7891501	7891574	<b>545,0</b>	
<b>100 cm</b> 2 cajones	Conjunto (mueble + lavabo)*	7891601	7891674	<b>639,0</b>	
<b>120 cm</b> 4 cajones	Conjunto (mueble + 2 lavabos)*	7891701	7891774	<b>1.083,0</b>	

\* Mueble Daily + encimera + lavabo Hera Square blanco

	 + 			€/u	
	Mueble Lavabo negro	BLANCO BRILLO	ROBLE RÚSTICO		
<b>60 cm</b> 2 cajones	Conjunto (mueble + lavabo)*	7892101	7892174	<b>501,0</b>	
<b>80 cm</b> 2 cajones	Conjunto (mueble + lavabo)*	7892201	7892274	<b>545,0</b>	
<b>100 cm</b> 2 cajones	Conjunto (mueble + lavabo)*	7892301	7892374	<b>639,0</b>	
<b>120 cm</b> 4 cajones	Conjunto (mueble + 2 lavabos)*	7892401	7892474	<b>1.083,0</b>	

\* Mueble Daily + encimera + lavabo Hera Square negro

# Daily + Hera <sup>N</sup>

mueble 1 cajón + 1 hueco + encimera + lavabo Hera Square





muebles



	 + 			€/u	
<b>60 cm</b> 1 cajón + 1 hueco	Conjunto (mueble + lavabo)*	7891801	7891874	<b>457,0</b>	 Guías Hettich
<b>80 cm</b> 1 cajón + 1 hueco	Conjunto (mueble + lavabo)*	7891901	7891974	<b>496,0</b>	
<b>100 cm</b> 1 cajón + 1 hueco	Conjunto (mueble + lavabo)*	7892001	7892074	<b>593,0</b>	

 Cajón con organizador

\* Mueble Daily + encimera + lavabo Hera Square blanco

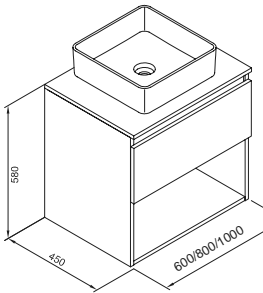
	 + 			€/u	
<b>60 cm</b> 1 cajón + 1 hueco	Conjunto (mueble + lavabo)*	7892501	7892574	<b>457,0</b>	
<b>80 cm</b> 1 cajón + 1 hueco	Conjunto (mueble + lavabo)*	7892601	7892674	<b>496,0</b>	
<b>100 cm</b> 1 cajón + 1 hueco	Conjunto (mueble + lavabo)*	7892701	7892774	<b>593,0</b>	

+ Mueble Daily + encimera + lavabo Hera Square negro

# Daily + Hera N

mueble + encimera + lavabo Hera 60x38

muebles



	 + 			€/u	
	Mueble Lavabo blanco	BLANCO BRILLO	ROBLE RÚSTICO		Soft Close
80 cm 2 cajones	Conjunto (mueble + lavabo)*	7892801	7892874	626,0	 Guías Hettich
100 cm 2 cajones	Conjunto (mueble + lavabo)*	7892901	7892974	730,0	
80 cm 1 cajón + 1 hueco	Conjunto (mueble + lavabo)*	7893001	7893074	567,0	
100 cm 1 cajón + 1 hueco	Conjunto (mueble + lavabo)*	7893101	7893174	678,0	

\* Mueble Daily + encimera + lavabo Hera 60x38 blanco

	 + 			€/u	
	Mueble Lavabo negro	BLANCO BRILLO	ROBLE RÚSTICO		Cajón con organizador
80 cm 2 cajones	Conjunto (mueble + lavabo)*	7893201	7893274	626,0	
100 cm 2 cajones	Conjunto (mueble + lavabo)*	7893301	7893374	730,0	
80 cm 1 cajón + 1 hueco	Conjunto (mueble + lavabo)*	7893401	7893474	567,0	
100 cm 1 cajón + 1 hueco	Conjunto (mueble + lavabo)*	7893501	7893574	678,0	

\* Mueble Daily + encimera + lavabo Hera 60x38 negro



Col.  
**H a n d y**

# Handy

2 cajones | 4 cajones

muebles



HANDY		 BLANCO BRILLO	 ANTRACITA BRILLO	 NOGAL	 GRIS	€/u
<b>60 cm</b>	Pack *	7916101	7916184	7916185	7916117	<b>414,0</b>
<b>2 cajones</b>	Conjunto (mueble + lavabo)	7894101	7894184	7894185	7894117	<b>335,0</b>
<b>70 cm</b>	Pack *	7916201	7916284	7916285	7916217	<b>439,0</b>
<b>2 cajones</b>	Conjunto (mueble + lavabo)	7894201	7894284	7894285	7894217	<b>366,0</b>
<b>80 cm</b>	Pack *	7916301	7916384	7916385	7916317	<b>463,0</b>
<b>2 cajones</b>	Conjunto (mueble + lavabo)	7894301	7894384	7894385	7894317	<b>377,0</b>
<b>100 cm</b>	Pack *	7916401	7916484	7916485	7916417	<b>544,0</b>
<b>2 cajones</b>	Conjunto (mueble + lavabo)	7894401	7894484	7894485	7894417	<b>449,0</b>
<b>120 cm</b>	Pack *	7916501	7916584	7916585	7916517	<b>860,0</b>
<b>4 cajones</b>	Conjunto (mueble + lavabo)	7894501	7894584	7894585	7894517	<b>741,0</b>

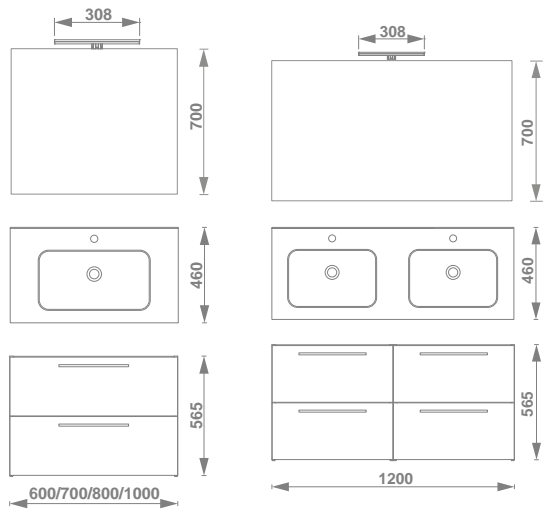

Soft Close

\* Pack: mueble+lavabo+espejo Only+luminaria Daily 30 LED 8W.



# Handy

2 puertas



muebles

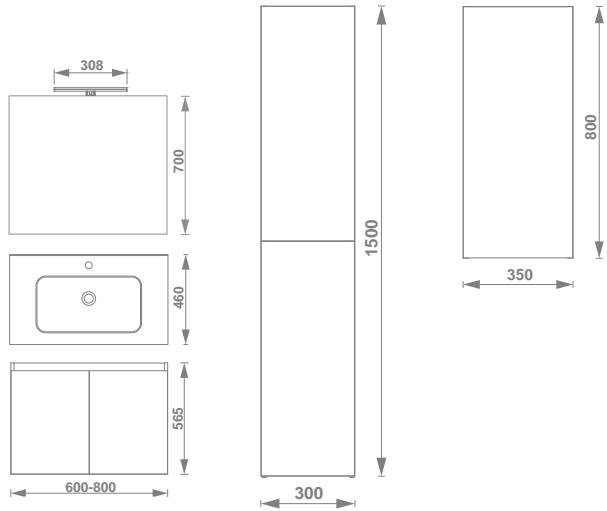

HANDY		BLANCO BRILLO	ANTRACITA BRILLO	NOGAL	GRIS	€/u
<b>60 cm</b>	Pack *	7916601	7916684	7916685	7916617	<b>381,0</b>
<b>2 puertas</b>	Conjunto (mueble + lavabo)	7894601	7894684	7894685	7894617	<b>264,0</b>
<b>80 cm</b>	Pack *	7916701	7916784	7916785	7916717	<b>404,0</b>
<b>2 puertas</b>	Conjunto (mueble + lavabo)	7894701	7894784	7894785	7894717	<b>279,0</b>

HANDY		BLANCO BRILLO	ANTRACITA BRILLO	NOGAL	GRIS	€/u
<b>Columna 30x150x28 cm</b>		3804601	3804684	3804685	3804617	<b>288,0</b>
<b>2 puertas</b>						

HANDY		BLANCO BRILLO	ANTRACITA BRILLO	NOGAL	GRIS	€/u
<b>Alto 35x80x15 cm</b>		3804701	3804784	3804785	3804717	<b>210,0</b>
<b>1 puerta</b>						



Soft Close

\* Pack: mueble+lavabo+espejo Only+luminaria Daily 30 LED 8W.



Col.  
**M i k**

# Mik

1 puerta



muebles



MIK		BLANCO BRILLO	ANTRACITA BRILLO	NOGAL	GRIS	€/u
40 cm 1 puerta	Pack *	7916001	7916084	7916085	7916017	299,0

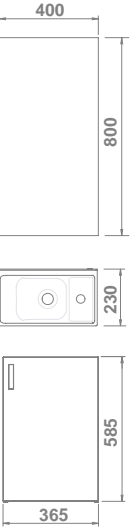



## Espejos y Luminarias

# Espejos y luminarias

Espejos con luz



## ESPEJO EIRE

Iluminación Led integrada.  
Temperatura de color 5700°K.  
Cristal 4mm.  
Profundidad 3mm.  
Posibilidad de borde decorativo.

3851800 ESPEJO SIN BORDE DECORATIVO 240,0  
**45X90 CM**

38518 ESPEJO CON BORDE DECORATIVO 260,0  
**45X90 CM**

● 02 Negro ● 01 Blanco ● 52 Oro

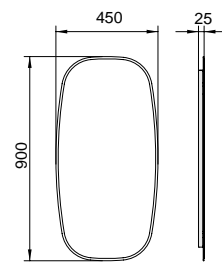

## ESPEJO MOIRA

Iluminación Led integrada.  
Temperatura de color 5700°K.  
Cristal 4mm.  
Profundidad 3mm.  
Posibilidad de borde decorativo.

3851900 ESPEJO SIN BORDE DECORATIVO 250,0  
**60X85 CM**

38519 ESPEJO CON BORDE DECORATIVO 270,0  
**60X85CM**

● 02 Negro ● 01 Blanco ● 52 Oro

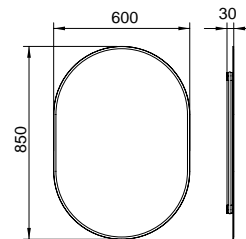

espejos y luminarias



# Espejos y luminarias

Espejos con luz



€/u

## ESPEJO IRON

Iluminación Led integrada.  
Temperatura de color 4000°K.  
Cristal 4mm.  
Profundidad 2,5mm.  
Borde decorativo.

38502 ESPEJO IRON Ø 60 CM  
ILUMINACIÓN LED 12W 250,0

38503 ESPEJO IRON Ø 80 CM  
ILUMINACIÓN LED 12W 260,0

38504 ESPEJO IRON Ø 100 CM  
ILUMINACIÓN LED 30W 310,0

● 02 Negro ● 01 Blanco ● 52 Oro

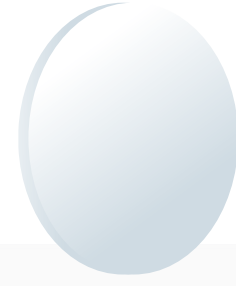
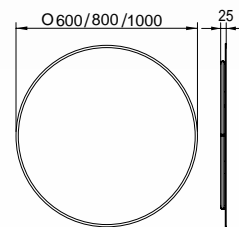

€/u

## ESPEJO LYA-N

Iluminación Led integrada.  
Temperatura de color 4000°K.  
Cristal canto pulido 4mm  
Profundidad 2,5cm

38491 ESPEJO LYA-N Ø 60 CM 205,0

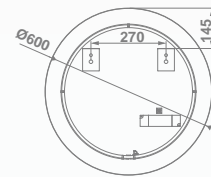

38492 ESPEJO LYA-N Ø 75 CM 243,0

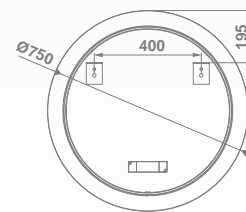

38493 ESPEJO LYA-N DE Ø 90 CM 302,5

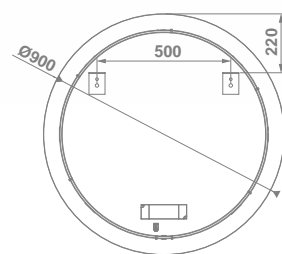

# Espejos y luminarias

Espejos con luz



€/u

38475 **ESPEJO ADDOR 60X80 CM** 124,0  
Iluminación led 10 W.

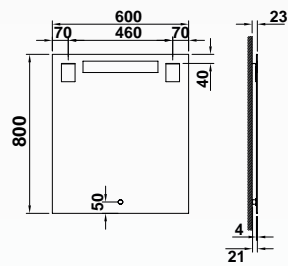

38476 **ESPEJO ADDOR 80X80 CM** 141,5  
Iluminación led 12 W.

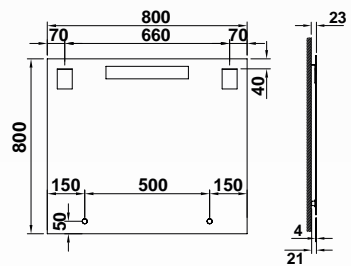

38477 **ESPEJO ADDOR 100X80 CM** 153,5  
Iluminación led 15 W.

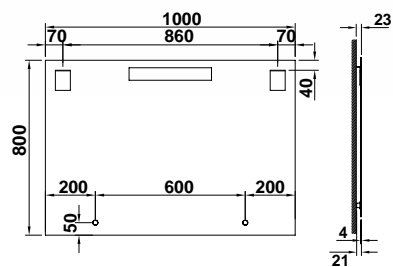

€/u

**ESPEJO ANNE 50X100 CM**  
Iluminación Led integrada 30W  
Temperatura de color 4000K  
Cristal de 4 mm  
Profundidad 3 mm

38514 **50X100 CM** 210,0

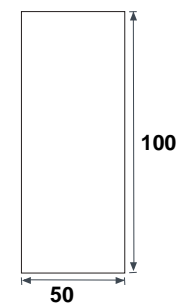

espejos y luminarias

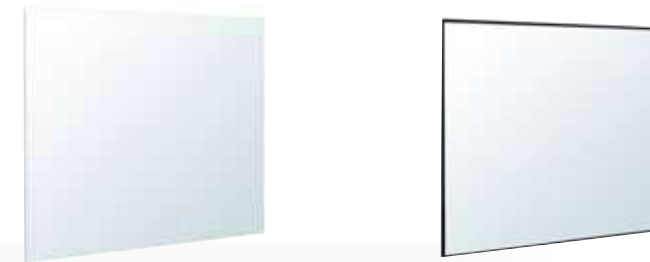

**ESPEJO KUADRAT**  
Iluminación Led integrada 20W.  
Temperatura de color 4000°K.  
Cristal 4mm.  
Profundidad 2,5mm.  
Posibilidad de borde decorativo.

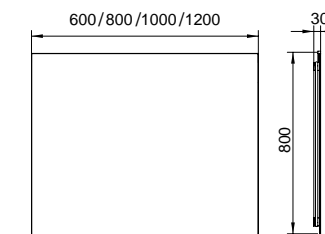

38506 **ESPEJO KUADRAT 60X80CM**  
00 Sin borde 232,0 ● 02 Negro 242,0

38507 **ESPEJO KUADRAT 80X80CM**  
00 Sin borde 252,0 ● 02 Negro 262,0

38508 **ESPEJO KUADRAT 100X80CM**  
00 Sin borde 282,0 ● 02 Negro 302,0

38509 **ESPEJO KUADRAT 120X80CM**  
00 Sin borde 307,0 ● 02 Negro 330,0



# Espejos y luminarias

Espejos sin luz

espejos y luminarias

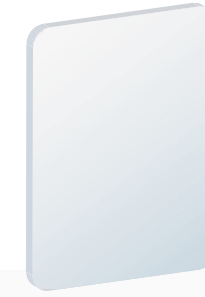
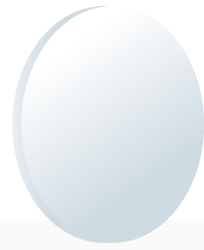

	€/u
<b>ESPEJO TOUR</b> Luna pulida de 4mm. Profundidad 2cm	
38488 <b>Ø 75 CM</b>	201,0
38489 <b>Ø 90 CM</b>	223,0

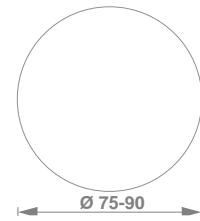

	€/u
<b>ESPEJO NERO</b> Borde decorativo negro mate Cristal canto pulido 4mm Profundidad 2,1cm	

38495 <b>ESPEJO NERO Ø 60 CM</b>	183,5
----------------------------------	-------

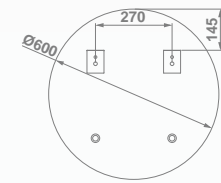

38496 <b>ESPEJO NERO Ø 80 CM</b>	205,0
----------------------------------	-------

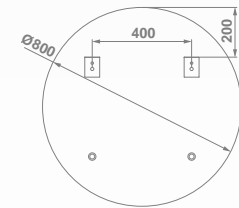

38497 <b>ESPEJO NERO Ø 100 CM</b>	237,0
-----------------------------------	-------

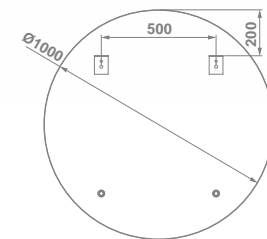

	€/u
<b>ESPEJO CURVE</b> Cristal pulido con cantos redondeados Profundidad 2cm	
38484 <b>60X70 CM</b>	140,5
38485 <b>80X70 CM</b>	154,5
38486 <b>100X70 CM</b>	176,0
38487 <b>120X70 CM</b>	205,0

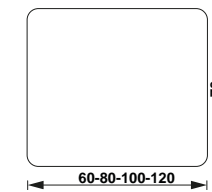

	€/u
<b>ESPEJO ONLY</b> Perfil acabado gris. Profundidad 2,6 cm	
38478 <b>60X70 CM</b>	72,4
38479 <b>70X70 CM</b>	78,8
38480 <b>80X70 CM</b>	84,0
38481 <b>90X70 CM</b>	93,0
38482 <b>100X70 CM</b>	98,0
38483 <b>120X70 CM</b>	116,5

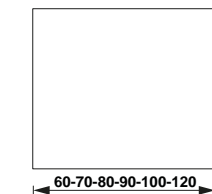



# Espejos y luminarias

Luminarias



€/u

- 38265 **LUMINARIA DAILY 60 CM**  
Luminaria led 12 W.  
● 00 Cromo 66,0 ● 02 Negro 66,0
- 38266 **LUMINARIA DAILY 45 CM**  
Luminaria led 10 W.  
● 00 Cromo 54,0 ● 02 Negro 54,0
- 38267 **LUMINARIA DAILY 30 CM**  
Luminaria led 8 W.  
● 00 Cromo 47,0 ● 02 Negro 47,0

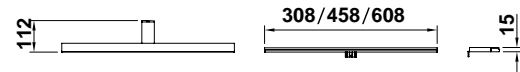

€/u

- 38471 **LUMINARIA KUL 9 CM**  
Luminaria 5W.  
Posibilidad de instalación  
en cualquier punto del espejo.

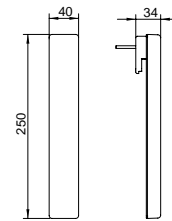



# Accesorios

para muebles

# Sion



53140 **TOALLERO COLGANTE 37,5 CM** €/u 74,2  
 ● 00 Cromo ● 02 Negro

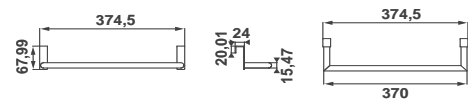

53143 **PORTARROLLOS COLGANTE** €/u 49,8  
 ● 00 Cromo ● 02 Negro

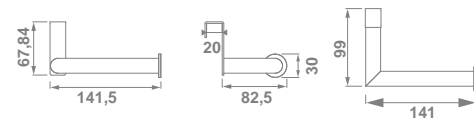

53141 **TOALLERO COLGANTE DE 27,5** €/u 66,8  
 ● 00 Cromo ● 02 Negro

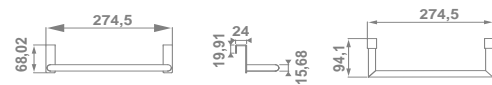

53144 **SOPORTE SECADOR COLGANTE** €/u 37,1  
 ● 00 Cromo ● 02 Negro

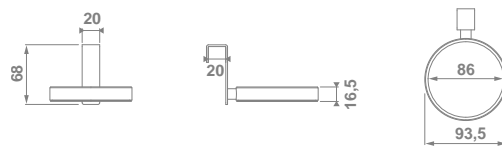

53142 **PERCHA COLGANTE** €/u 40,3  
 ● 00 Cromo ● 02 Negro

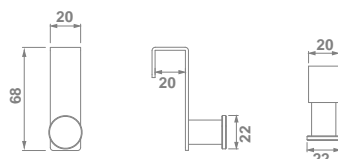

53145 **SOPORTE PLANCHA PELO COLGANTE** €/u 50,9  
 ● 00 Cromo ● 02 Negro

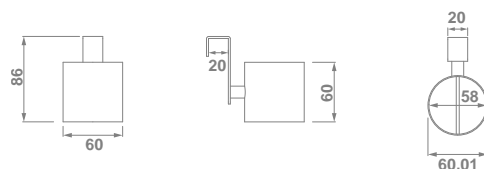

38061 **PATAS DESIGN** €/u 64,5  
 Altura pata 27cm  
 ● 00 Cromo



38062 **PATAS** €/u 44,3  
 Altura pata 27cm  
 ● 00 Cromo



**accesorios**





# accesorios

índice

304  
MORGAN 

312  
SION

320  
MADOC 

330  
KAY SQUARE 

342  
KAY ROUND 

352  
AVALON

Accesorios  
**Morgan**



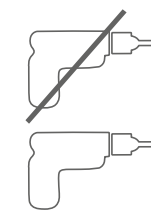

**FÁCIL INSTALACIÓN SISTEMA DUAL**  
Morgan puede instalarse mediante tornillería tradicional o mediante adhesivo Quick Fix.

**QUICK FIX**



**FIJACIÓN ADHESIVA QUICK FIX**  
Permite montar los accesorios con adhesivo de alta calidad sin necesidad de hacer agujeros en la pared.



**RESISTENCIA DE CARGA 5 KG**  
La colección ha superado exigentes tests de durabilidad y resistencia, que aseguran una larga vida al producto.



**NO USAR EN SUPERFICIES PINTADAS NI EN PAREDES RUGOSAS**



**10 AÑOS DE GARANTÍA**



**ACABADO CROMO**



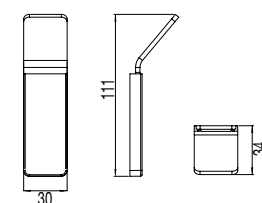

53215 PERCHA €/u 28,4  
● 00 Cromo

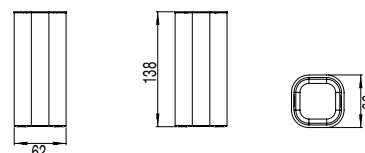

53218 PORTACEPILLOS €/u 42,0  
● 00 Cromo



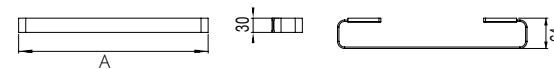

53221 TOALLERO 40CM €/u 74,2  
53222 TOALLERO 60CM €/u 86,5  
● 00 Cromo



Referencia	A
53221	400
53222	600

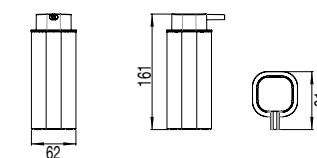

53214 DOSIFICADOR €/u 55,6  
● 00 Cromo



53224 TOALLERO DE ARO €/u 53,1  
● 00 Cromo

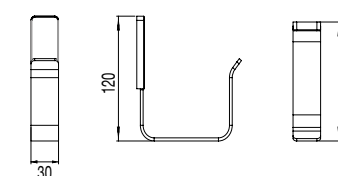

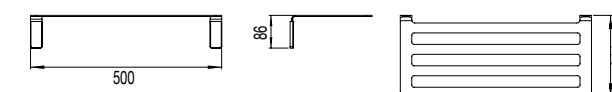

53223 ESTANTE TOALLERO €/u 185,4  
● 00 Cromo





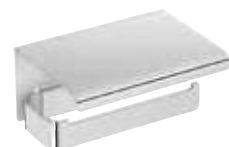
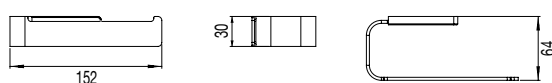

53219 PORTARROLLO 48,2 €/u  
● 00 Cromo



53220 PORTARROLLO CON TAPA 66,7 €/u  
● 00 Cromo

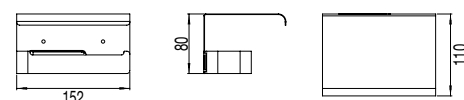

53212 ESCOBILLERO DE SUELO 95,2 €/u  
● 00 Cromo

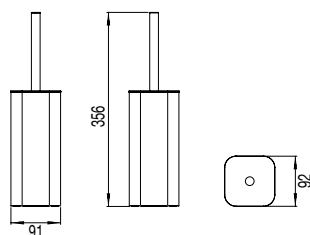

53216 CONTENEDOR DE DUCHA 80,3 €/u  
● 00 Cromo

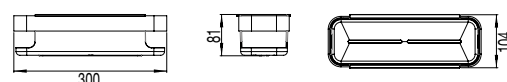

53217 CONTENEDOR DE DUCHA DE RINCÓN 20CM 80,3 €/u  
● 00 Cromo

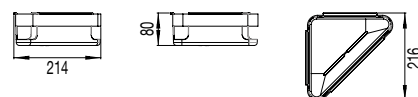

53225 PAPELERA 5L INOX BRILLO 142,1 €/u  
53213 PAPELERA 5L CROMO 181,7 €/u  
● 00 Cromo

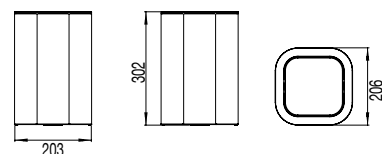

Accesorios  
**Sion**



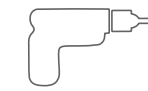

**FÁCIL INSTALACIÓN**  
Instalación mediante tornillería  
con fijaciones ocultas.



**RESISTENCIA DE CARGA 5 KG**  
La colección ha superado exigentes tests de  
durabilidad y resistencia, que aseguran una  
larga vida al producto.

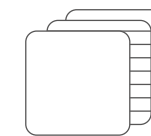

**FABRICADOS EN LATÓN  
Y ALUMINIO FUNDIDO**



**ANTICORROSIÓN  
10 AÑOS DE GARANTÍA**



**ACABADOS CROMO Y NEGRO**



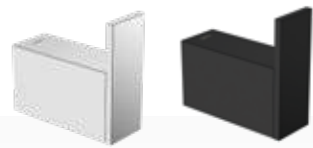

53130 PERCHA €/u 20,7  
● 00 Cromo ● 02 Negro

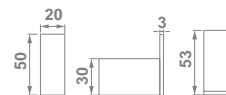

53131 PORTARROLLOS SIN TAPA €/u 46,5  
● 00 Cromo ● 02 Negro

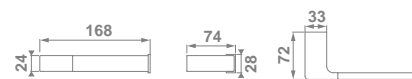

53152 PORTARROLLOS CON TAPA €/u 43,7  
● 00 Cromo ● 02 Negro

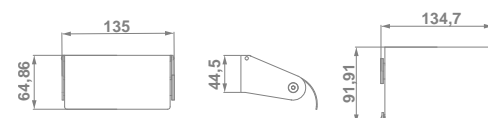

53132 TOALLERO 30 CM €/u 72,1  
● 00 Cromo ● 02 Negro

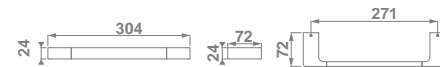

53133 TOALLERO 40 CM €/u 83,0  
● 00 Cromo ● 02 Negro



53134 TOALLERO 50 CM €/u 87,3  
● 00 Cromo ● 02 Negro

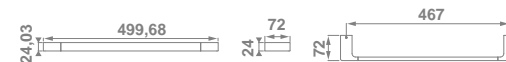

53135 ESCOBILLERO DE SUELO €/u 103,7  
● 00 Cromo ● 02 Negro

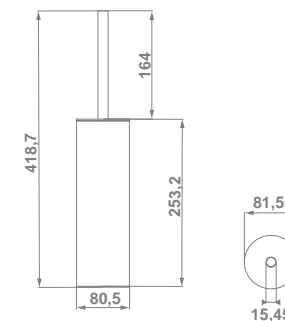



53140 TOALLERO COLGANTE 37,5 CM €/u 74,2  
● 00 Cromo ● 02 Negro

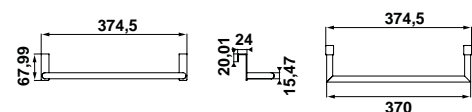

53141 TOALLERO COLGANTE DE 27,5 €/u 66,8  
● 00 Cromo ● 02 Negro

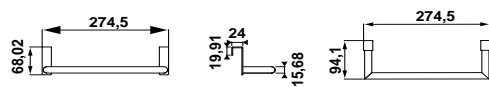

53142 PERCHA COLGANTE €/u 40,3  
● 02 Negro ● 00 Cromo

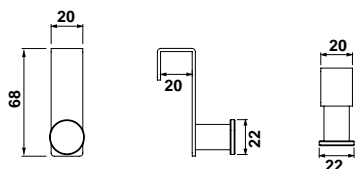

53143 PORTARROLLOS COLGANTE €/u 49,8  
● 00 Cromo ● 02 Negro

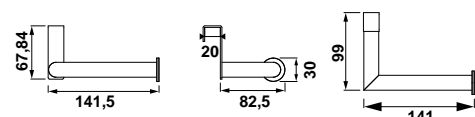

53144 SOPORTE SECADOR COLGANTE €/u 37,1  
● 00 Cromo ● 02 Negro

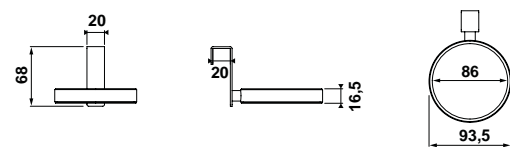

53145 SOPORTE PLANCHA PELO COLGANTE €/u 50,9  
● 00 Cromo ● 02 Negro

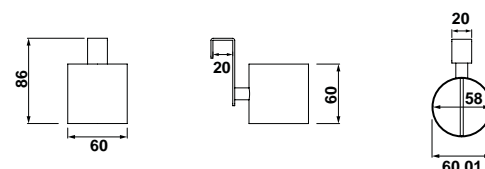

Accesorios  
**Madoc**



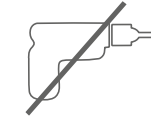

**FÁCIL INSTALACIÓN**  
Instalación mediante sistema adhesivo, sin taladro ni tornillería.

QUICK FIX

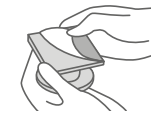

**FIJACIÓN ADHESIVA QUICK FIX**  
Permite montar los accesorios con adhesivo de alta calidad sin necesidad de hacer agujeros en la pared.



**RESISTENCIA DE CARGA 5 KG**  
La colección ha superado exigentes tests de durabilidad y resistencia, que aseguran una larga vida al producto.



**NO USAR EN SUPERFICIES PINTADAS NI EN PAREDES RUGOSAS**



**10 AÑOS DE GARANTÍA**



**ACABADOS CROMO, BLANCO Y NEGRO**



52984 PERCHA €/u 27,2  
 ● 00 Cromo ○ 01 Blanco ● 02 Negro

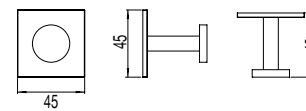

52985 PERCHA DOBLE €/u 49,4  
 ● 00 Cromo ○ 01 Blanco ● 02 Negro

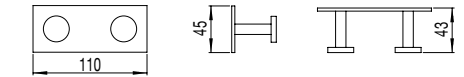

52986 PERCHA COLGANTE €/u 40,3  
 ● 00 Cromo ○ 01 Blanco ● 02 Negro

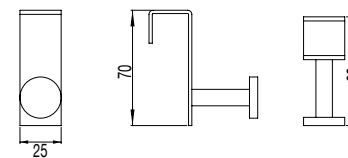

52987 ESTANTE DE VIDRIO 40CM €/u 60,6  
 ● 00 Cromo ○ 01 Blanco ● 02 Negro

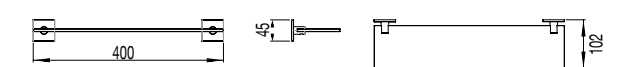

52989 PORTACEPILLOS €/u 50,7  
 ● 00 Cromo ○ 01 Blanco ● 02 Negro

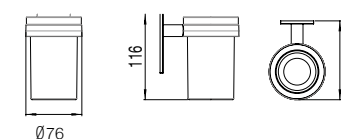

52983 DOSIFICADOR €/u 60,6  
 ● 00 Cromo ○ 01 Blanco ● 02 Negro

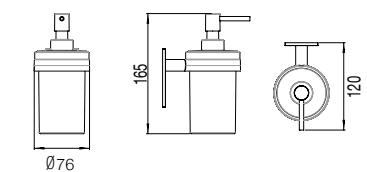





52998 TOALLERO DE ARO €/u 64,3  
● 00 Cromo ○ 01 Blanco ● 02 Negro

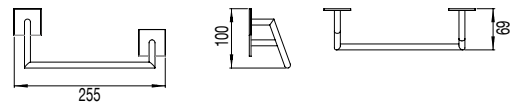

52992 TOALLERO 30CM €/u 59,3  
● 00 Cromo ○ 01 Blanco ● 02 Negro

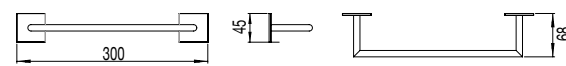

52993 TOALLERO 45CM €/u 70,5  
● 00 Cromo ○ 01 Blanco ● 02 Negro

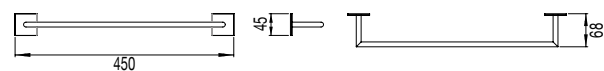

52994 TOALLERO 60CM €/u 79,1  
● 00 Cromo ○ 01 Blanco ● 02 Negro

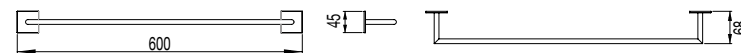

52995 TOALLERO COLGANTE 28CM €/u 66,8  
● 00 Cromo ○ 01 Blanco ● 02 Negro

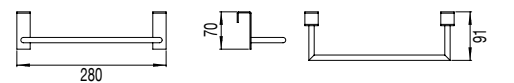

52996 TOALLERO COLGANTE 38CM €/u 74,2  
● 00 Cromo ○ 01 Blanco ● 02 Negro

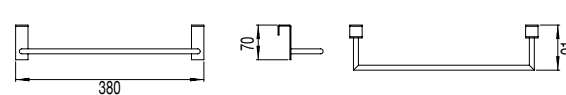



52997 TOALLERO LATERAL €/u 51,9  
● 00 Cromo ○ 01 Blanco ● 02 Negro

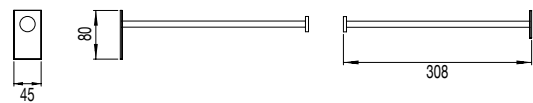

52991 PORTARROLLO CON TAPA €/u 54,4  
● 00 Cromo ○ 01 Blanco ● 02 Negro

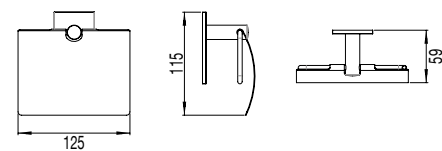

52982 ESCOBILLERO DE PARED €/u 70,5  
● 00 Cromo ○ 01 Blanco ● 02 Negro

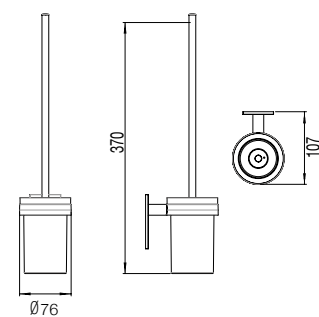

52990 PORTARROLLO €/u 47,0  
● 00 Cromo ○ 01 Blanco ● 02 Negro

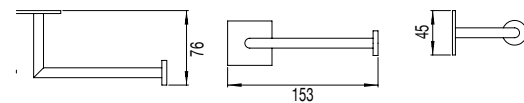

52999 PORTARROLLO DE RESERVA €/u 47,0  
● 00 Cromo ○ 01 Blanco ● 02 Negro

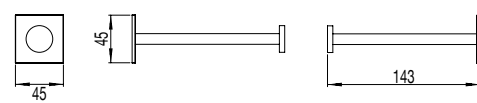

52988 CONTENEDOR DE DUCHA (30X11X10) €/u 114,9  
● 00 Cromo ○ 01 Blanco ● 02 Negro

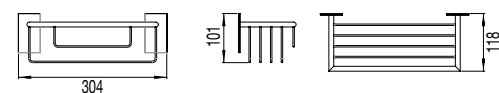

Accesorios  
**Kay Square**



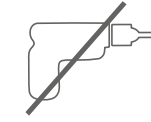

**FÁCIL INSTALACIÓN**  
Instalación mediante sistema adhesivo,  
sin taladro ni tornillería.

**QUICK FIX**

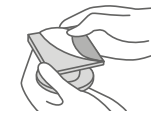

**FIJACIÓN ADHESIVA QUICK FIX**  
Permite montar los accesorios con adhesivo de  
alta calidad sin necesidad de hacer agujeros en  
la pared.



**RESISTENCIA DE CARGA 5 KG**  
La colección ha superado exigentes tests de  
durabilidad y resistencia, que aseguran una  
larga vida al producto.



**NO USAR EN SUPERFICIES PINTADAS  
NI EN PAREDES RUGOSAS**



**10 AÑOS DE GARANTÍA**



**ACABADO CROMO**



53189 PERCHA €/u 26,0

● 00 Cromo

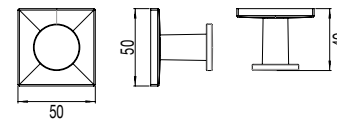

53200 PORTACEPILLOS €/u 44,5

● 00 Cromo

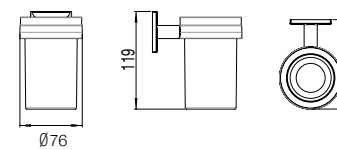

53187 DOSIFICADOR €/u 101,4

● 00 Cromo

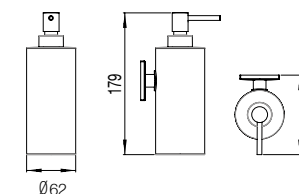

53191 JABONERA €/u 40,8

● 00 Cromo

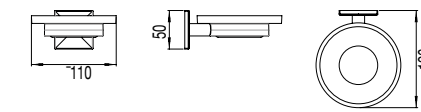

53188 DOSIFICADOR DE VIDRIO €/u 48,2

● 00 Cromo

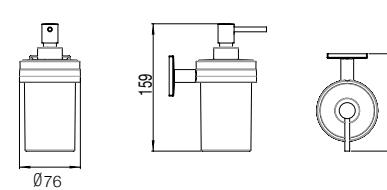

53195 ESTANTE DE VIDRIO 40CM €/u 54,4

53196 ESTANTE DE VIDRIO 60CM €/u 68,0

● 00 Cromo

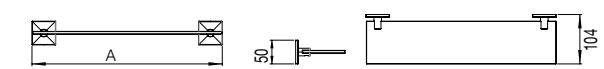

Referencia	A
53195	400
53196	600



53208 TOALLERO DE ARO €/u 49,4  
● 00 Cromo

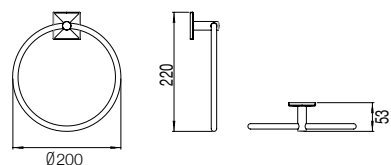

53207 ESTANTE TOALLERO €/u 134,7  
● 00 Cromo

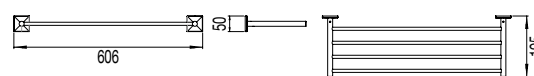

53203 PORTARROLLO CON TAPA €/u 48,2  
● 00 Cromo

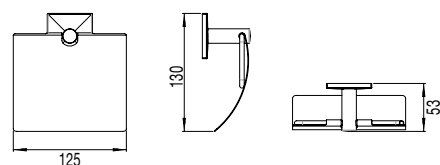

53204 TOALLERO 30CM €/u 51,9  
53205 TOALLERO 50CM €/u 58,1  
53206 TOALLERO 60CM €/u 70,5  
● 00 Cromo

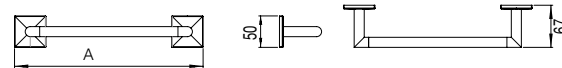

Referencia	A
53204	305
53205	455
53206	605



53201 PORTARROLLO DERECHA €/u 40,8  
53202 PORTARROLLO IZQUIERDA €/u 40,8  
● 00 Cromo

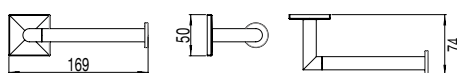

53185 ESCOBILLERO DE VIDRIO €/u 58,1  
● 00 Cromo

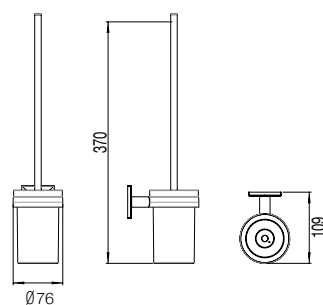



53186 ESCOBILLERO DE PARED €/u 136,0

● 00 Cromo

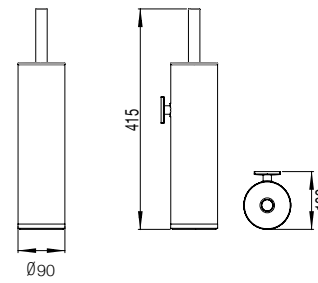

53198 CONTENEDOR DE DUCHA (15x11x5) €/u 49,4

● 00 Cromo

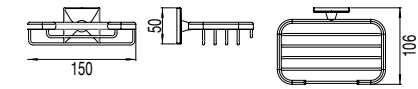

53209 CONTENEDOR DE DUCHA ESCALÓN DERECHO €/u 92,7

● 00 Cromo

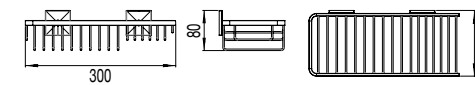

53230 CONTENEDOR DE DUCHA ESCALÓN IZQUIERDO €/u 92,7

● 00 Cromo

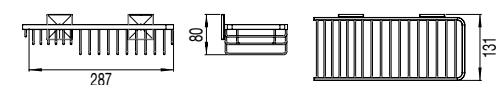

53194 CONTENEDOR DE DUCHA 30x13x13 €/u 101,4

● 00 Cromo

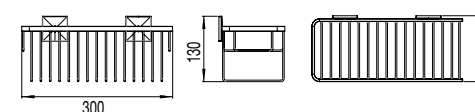

53199 CONTENEDOR DE DUCHA DE RINCÓN 20x21x8 €/u 74,2

● 00 Cromo

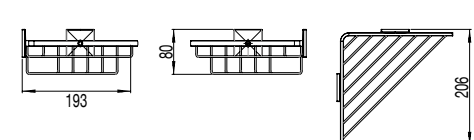

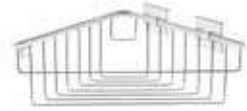

		€/u
53193	CONTENEDOR DE DUCHA DE RINCÓN 25x26x13	107,5
53211	CONTENEDOR DE DUCHA DE RINCÓN 25x26x8	81,6

● 00 Cromo

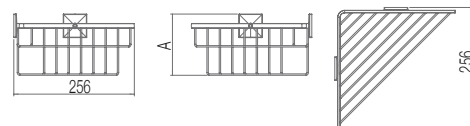

Referencia	A
53193	133
53211	83



		€/u
53190	CONTENEDOR DE DUCHA 20x11x5	68,0
53192	CONTENEDOR DE DUCHA 30x13x7	81,6
53197	CONTENEDOR DE DUCHA 40x13x6	101,4

● 00 Cromo

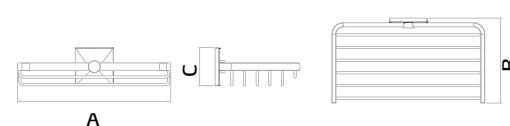

Referencia	A	B	C
53190	200	111	55
53192	300	131	68
53197	400	131	63



		€/u
53184	PAPELERA 5L INOX BRILLO	37,1

● 00 Cromo

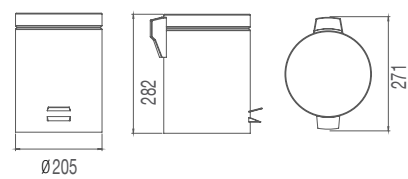



Accesorios

# Kay Round





**FÁCIL INSTALACIÓN**  
Instalación mediante sistema adhesivo,  
sin taladro ni tornillería.

QUICK FIX



**FIJACIÓN ADHESIVA QUICK FIX**  
Permite montar los accesorios con adhesivo de  
alta calidad sin necesidad de hacer agujeros en  
la pared.



**RESISTENCIA DE CARGA 5 KG**  
La colección ha superado exigentes tests de  
durabilidad y resistencia, que aseguran una  
larga vida al producto.



**NO USAR EN SUPERFICIES PINTADAS  
NI EN PAREDES RUGOSAS**



**10 AÑOS DE GARANTÍA**



**ACABADO CROMO**



53161 PERCHA €/u 26,0  
● 00 Cromo

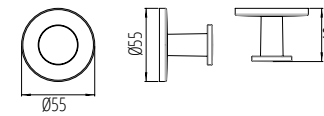

53163 JABONERA €/u 40,8  
● 00 Cromo

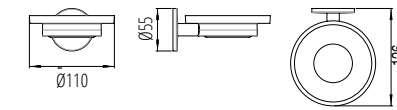

53172 PORTACEPILLOS €/u 44,5  
● 00 Cromo

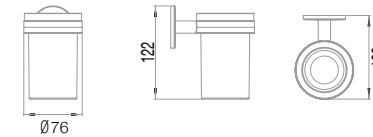

53160 DOSIFICADOR DE VIDRIO €/u 48,2  
● 00 Cromo

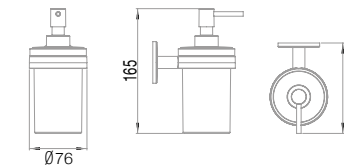

53159 DOSIFICADOR €/u 101,4  
● 00 Cromo

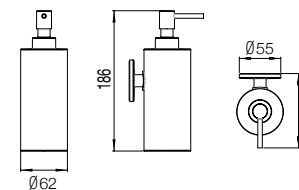

53167 ESTANTE DE VIDRIO 40CM €/u 54,4  
53168 ESTANTE DE VIDRIO 60CM €/u 68,0  
● 00 Cromo

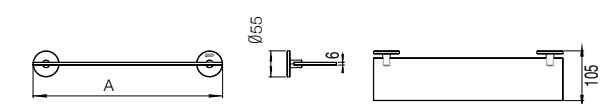

Referencia	A
53167	400
53168	600



53180 TOALLERO DE ARO €/u 49,4  
● 00 Cromo

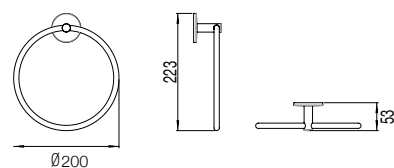

53179 ESTANTE TOALLERO €/u 134,7  
● 00 Cromo

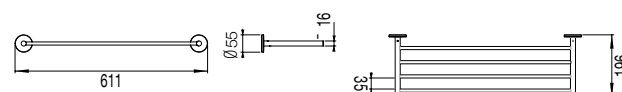

53175 PORTARROLLO CON TAPA €/u 48,2  
● 00 Cromo

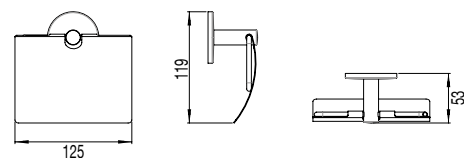

53176 TOALLERO 30CM €/u 51,9  
53177 TOALLERO 50CM €/u 58,1  
53178 TOALLERO 60CM €/u 70,5  
● 00 Cromo

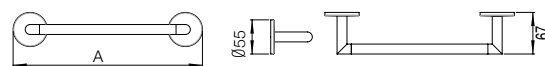

Referencia	A
53176	305
53177	455
53178	605



53173 PORTARROLLO DERECHA €/u 40,8  
53174 PORTARROLLO IZQUIERDA €/u 40,8  
● 00 Cromo

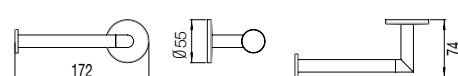

53157 ESCOBILLERO DE VIDRIO €/u 58,1  
● 00 Cromo

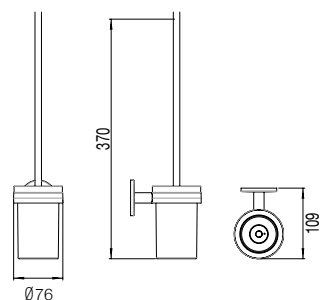

53158 ESCOBILLERO DE PARED €/u 136,0  
● 00 Cromo

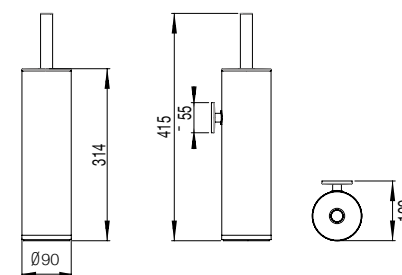

53181 CONTENEDOR DE DUCHA ESCALÓN DERECHO €/u 92,7  
● 00 Cromo

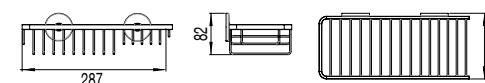

53166 CONTENEDOR DE DUCHA 30x13x13 €/u 101,4  
● 00 Cromo

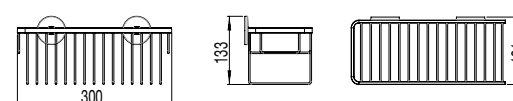

53170 CONTENEDOR DE DUCHA (15x11x5) €/u 49,4  
● 00 Cromo

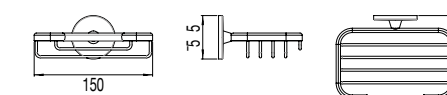

53182 CONTENEDOR DE DUCHA ESCALÓN IZQUIERDO €/u 92,7  
● 00 Cromo

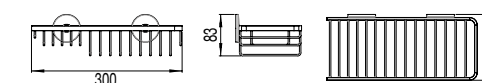

53171 CONTENEDOR DE DUCHA DE RINCÓN 20x21x8 €/u 74,2  
● 00 Cromo

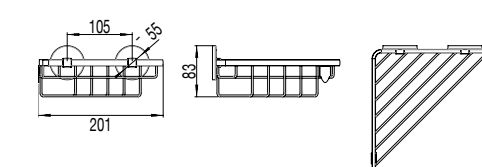

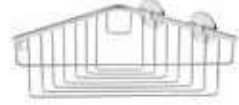

		€/u
53165	CONTENEDOR DE DUCHA DE RINCÓN 25x26x13	107,5
53183	CONTENEDOR DE DUCHA DE RINCÓN 25x26x8	81,6

● 00 Cromo

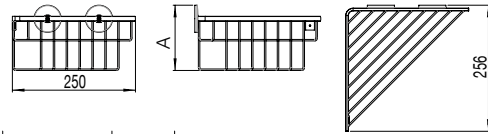

Referencia	A
53165	133
53183	83



		€/u
53162	CONTENEDOR DE DUCHA 20x11x5	68,0
53164	CONTENEDOR DE DUCHA 30x13x7	81,6
53169	CONTENEDOR DE DUCHA 40x13x6	101,4

● 00 Cromo

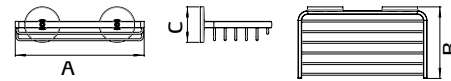

Referencia	A	B	C
53162	200	111	55
53164	300	131	68
53169	400	131	63



		€/u
53184	PAPELERA 5L INOX BRILLO	37,1

● 00 Cromo

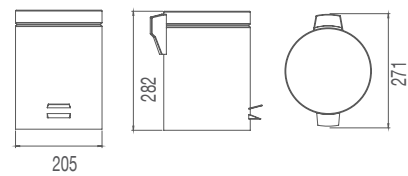

Accesorios  
**Avalon**



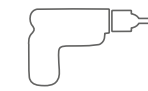

**FÁCIL INSTALACIÓN**  
Instalación mediante tornillería  
con fijaciones ocultas.



**RESISTENCIA DE CARGA 5 KG**  
La colección ha superado exigentes tests de  
durabilidad y resistencia, que aseguran una  
larga vida al producto.

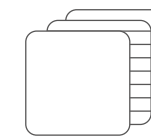

**FABRICADOS EN LATÓN  
Y ALUMINIO FUNDIDO**



**ANTICORROSIÓN  
10 AÑOS DE GARANTÍA**



**ACABADO CROMO**





53148 PERCHA €/u  
20,3

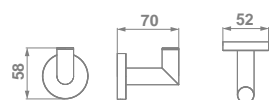

53149 PERCHA RECTA €/u  
20,3

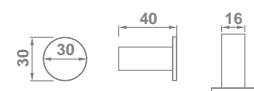

53150 TOALLERO 45 CM €/u  
47,5



53151 TOALLERO 60 CM €/u  
54,3

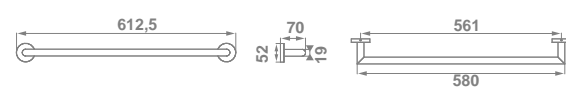

53152 PORTARROLLOS CON TAPA €/u  
43,7

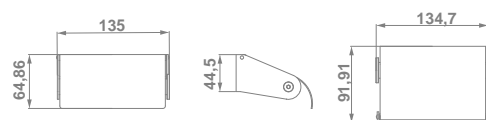

53153 PORTARROLLOS SIN TAPA €/u  
34,0

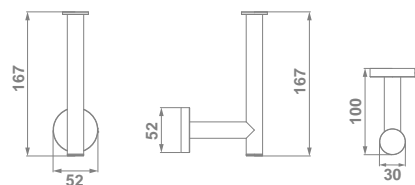

53154 PORTARROLLOS DE RESERVA €/u  
34,0

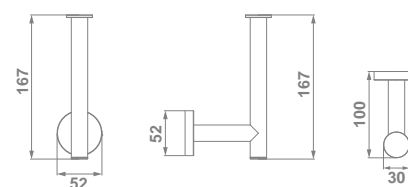

53155 TOALLERO ESTANTE €/u  
109,2

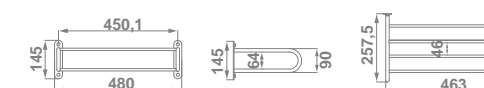



# urinarios y piezas especiales



# urinarios y piezas especiales



## Arq.



		€/u
22700	<b>URINARIO ARQ.</b> 31x29x52,5 cm con tapa, con sifón y juego de fijación.	310,0

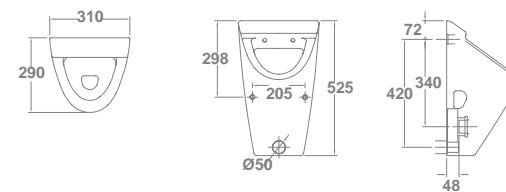

## Repuestos

53505	Bolsa accesorios urinario Minor y Arq. (sifón desagüe, racor, goma).	68,0
-------	--	------

## Argos



		€/u
29700	<b>URINARIO ARGOS</b> 47x32,5x65 cm con rociador, válvula-desagüe, sifón, pletina y juego de fijación.	301,0

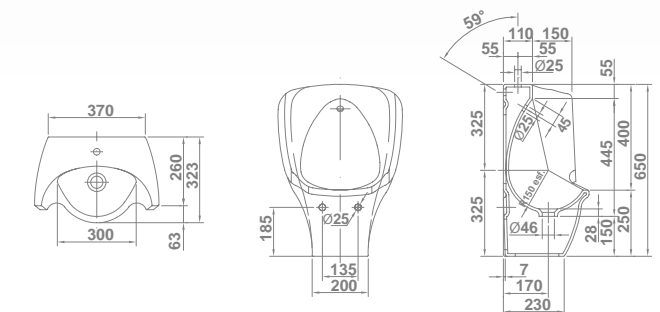



## Repuestos

53740	Accesorios urinario Argos (rociador, válvula-desagüe, sifón, pletina y juego de fijación).	114,3
-------	--	-------

# urinaros y piezas especiales



**Minor**

29701 **URINARIO MINOR** 31x29x52,5 cm sin tapa, con sifón y juego de fijación.   272,0 €/u

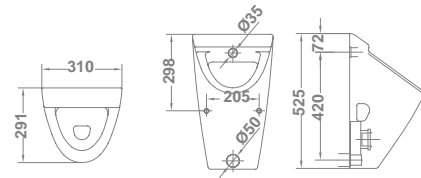



**Repuestos**

53685 Racor y goma urinario Minor. 9,5  
53505 Bolsa accesorios urinario Minor y Arq. (sifón desagüe, racor, goma...). 68,0



**Easy**

10119 **URINARIO EASY** 34,5 x 26,5 x 44 cm con goma de enchufe y fijaciones. Alimentación vertical.   47,0 €/u

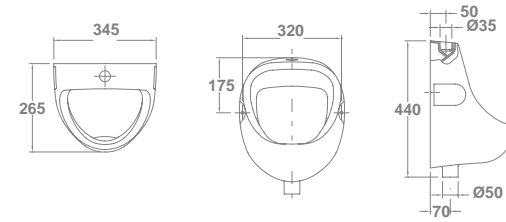

**Repuestos**

53686 Goma de enchufe urinario Easy. 2,9  
53290 Juego de fijación urinario Easy. 3,0



# urinarios y piezas especiales

## Mare



		€/u
29706	<b>SEPARADOR URINARIO</b>	156,0

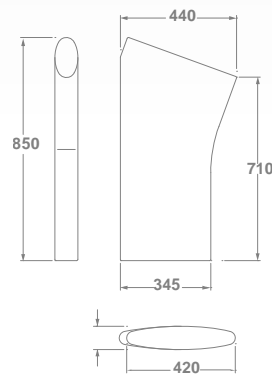

## Zinc

		€/u
10120	<b>VERTEDERO ZINC</b> (rejilla no incluida). 42,5x50x45 cm	181,0
10121	<b>REJILLA DE PVC</b> <b>VERTEDERO ZINC</b>	20,5

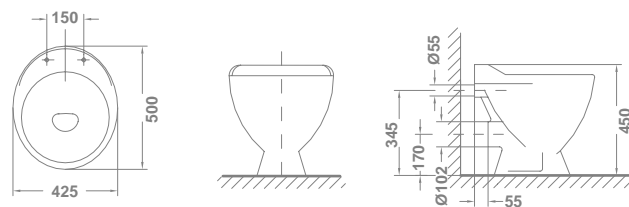

## Burgos-2



		€/u
29901	<b>LAVADERO BURGOS-2</b> 39x60x36 cm	194,5

En venta hasta fin de existencias

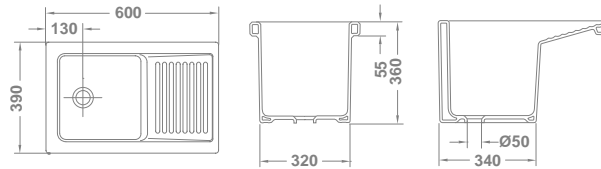

**platos  
de ducha**





# platos de ducha

índice

370

Guía rápida  
Búsqueda de plato  
por medida

374

**SURFACE**  
Base Surface  
Quantum

384

**PORCELANA**  
Gyda

390

**ACRÍLICO**  
Vita-N

402

**GALA-DRAIN**  
Gala-drain L  
Gala-drain SQ

platos de ducha rectangulares



platos de ducha rectangulares

		LONGITUD en CM											LONGITUD en CM										
		Ancho	80	90	100	110	120	130	140	150	160	170	180	200	Ancho								
<b>BASE SURFACE (3 cm)</b> surface  <b>QUANTUM (2,7 cm)</b> surface  <b>GYDA (8 cm)</b> porcelana  <b>VITA-N (4-5 cm)</b> acrílico 	70 cm				376	376	376	376		376	376	376			<b>BASE SURFACE (3 cm)</b> surface  <b>QUANTUM (2,7 cm)</b> surface  <b>GYDA (8 cm)</b> porcelana  <b>VITA-N (4-5 cm)</b> acrílico 								
					380	380	380	380		380	380	380	380	380									
						387		387			388												
						396		396			396		396	396									
<b>GYDA (8 cm)</b> porcelana 	72 cm			387											<b>GYDA (8 cm)</b> porcelana 								
<b>BASE SURFACE (3 cm)</b> surface  <b>QUANTUM (2,7 cm)</b> surface  <b>GYDA (8 cm)</b> porcelana  <b>VITA-N (4-5 cm)</b> acrílico 	80 cm				376	376	376	376		376	376	376	376	376	<b>BASE SURFACE (3 cm)</b> surface  <b>QUANTUM (2,7 cm)</b> surface  <b>GYDA (8 cm)</b> porcelana  <b>VITA-N (4-5 cm)</b> acrílico 								
					380	380	380	380		380	380	380	380	380									
						388		388															
						396	396	396	396		396	396	396	396	396								
<b>BASE SURFACE (3 cm)</b> surface  <b>QUANTUM (2,7 cm)</b> surface  <b>VITA-N (4-5 cm)</b> acrílico 	90 cm				377		377			377		377	377		<b>BASE SURFACE (3 cm)</b> surface  <b>QUANTUM (2,7 cm)</b> surface  <b>VITA-N (4-5 cm)</b> acrílico 								
					381		381			381		381	381										
						397		397			397		397										

platos de ducha angulares

		LONGITUD en CM		
		80x80 cm	90x90 cm	100x100 cm
<b>GYDA (8 cm)</b> porcelana		385	385	
<b>VITA-N (5,5 cm)</b> acrílico		392-393	392-393	392-393

platos de ducha cuadrados

		LONGITUD en CM			
		70x70 cm	80x80 cm	90x90 cm	100x100 cm
<b>QUANTUM (2,7 cm)</b> surface			380	381	
<b>GYDA (8 cm)</b> porcelana		386	386	386	
<b>VITA-N (5,5 cm)</b> acrílico			394-395	394-395	394-395



# Base Surface gala VIP

platos de ducha



## Acabado



Acabado texturizado en color blanco.

### CARACTERÍSTICAS TÉCNICAS

- Fabricación en Stonex®. Material de máxima duración y seguridad (resistente a impactos).
- Capa exterior de Gel Coat de máxima calidad ISO NPG.
- El diseño del plato proporciona un antideslizante natural para evitar posibles caídas.
- Evacuación de agua 35 l/min.
- Acabado texturizado en color blanco.
- Instalación sencilla y práctica.
- Textura natural imitando a la pizarra cálida al tacto.
- Extraplano: 3 cm de altura que facilitan la accesibilidad.
- Antibacteriano.
- Garantía de 2 años.
- Platos de grandes dimensiones, ideales para crear el espacio de ducha sustituyendo la bañera.



## 70

### PLATO BASE SURFACE A= 70cm

Extraplano 3 cm de altura con desagüe de 90 mm

			€/u
63972	100X70 cm		365,0
63973	110X70 cm		415,0
63968	120X70 cm		420,0
63974	130X70 cm		460,0
63969	140X70 cm		465,0
63975	150X70 cm		515,0
63970	160X70 cm		520,0



## 80

### PLATO BASE SURFACE A= 80cm

Extraplano 3 cm de altura con desagüe de 90 mm

			€/u
63976	100X80 cm		385,0
63977	110X80 cm		430,0
63960	120X80 cm		440,0
63978	130X80 cm		490,0
63962	140X80 cm		495,0
63979	150X80 cm		545,0
63964	160X80 cm		555,0
63980	170X80 cm		640,0
63981	180X80 cm		645,0
63966	200X80 cm		680,0



## 90

### PLATO BASE SURFACE A= 90cm

Extraplano 3 cm de altura con desagüe de 90 mm

			€/u
63982	100X90 cm		400,0
63961	120X90 cm		465,0
63963	140X90 cm		510,0
63965	160X90 cm		605,0
63983	180X90 cm		690,0
63967	200X90 cm		695,0



Dim.	Ref.	A	B	C
100x70	63972	100	79	24,5
110x70	63973	110	99	24,5
120x70	63968	120	99	24,5
130x70	63974	130	114	24,5
140x70	63969	140	114	24,5
150x70	63975	150	132	36,5
160x70	63970	160	132	36,5

100x80	63976	100	79	24,5
110x80	63977	110	99	24,5
120x80	63960	120	99	24,5
130x80	63978	130	114	24,5
140x80	63962	140	114	24,5
150x80	63979	150	132	36,5
160x80	63964	160	132	36,5
170x80	63980	170	162	42,5
180x80	63981	180	162	42,5
200x80	63966	200	162	42,5

100x90	63982	100	79	24,5
120x90	63961	120	99	24,5
140x90	63963	140	114	24,5
160x90	63965	160	132	36,5
180x90	63983	180	162	42,5
200x90	63967	200	162	42,5

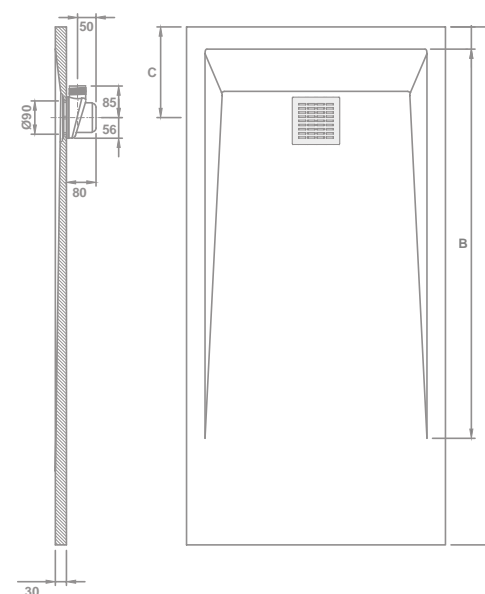

## + REPUESTOS Y ACCESORIOS €/u

50168 Válvula de desagüe de  $\varnothing$  90 mm para platos Base Surface. Altura 80 mm. 57,6

# Quantum<sup>N</sup>

platos de ducha



## CARACTERÍSTICAS TÉCNICAS

- Acabado texturizado *Stone* en color blanco.
- Fabricado en resina y cargas minerales.
- Capa exterior de Gel Coat ISO NPG.
- Marcado CE conforme a la norma EN 14527.
- Antideslizante de Clase III.
- Extraplano: 27 mm de altura.
- Peso reducido.
- Instalación sencilla y práctica.
- Garantía de 2 años.



# 70

### PLATO QUANTUM A= 70cm

Extraplano 2,7 cm de altura.  
Rejilla de acero inoxidable  
incluida. Válvula de desagüe  
no incluida



# 80

### PLATO QUANTUM A= 80cm

Extraplano 2,7 cm de altura.  
Rejilla de acero inoxidable  
incluida. Válvula de desagüe  
no incluida



# 90

### PLATO QUANTUM A= 90cm

Extraplano 2,7 cm de altura.  
Rejilla de acero inoxidable  
incluida. Válvula de desagüe  
no incluida

66600	100X70* cm	28	24	250,0
66601	110X70 cm	30	24	265,0
66602	120X70* cm	33	24	285,0
66603	130X70 cm	36	24	300,0
66604	140X70* cm	39	24	320,0
66605	150X70 cm	43	24	335,0
66606	160X70* cm	45	24	355,0
66607	170X70 cm	48	24	370,0
66608	180X70* cm	51	24	390,0

66630	80X80 cm	25	24	235,0
66610	100X80* cm	32	24	280,0
66611	110X80 cm	34	24	295,0
66612	120X80* cm	38	24	315,0
66613	130X80 cm	41	24	335,0
66614	140X80* cm	44	24	355,0
66615	150X80 cm	49	24	375,0
66616	160X80* cm	52	24	395,0
66617	170X80 cm	55	24	415,0
66618	180X80* cm	58	24	435,0
66619	200X80 cm	65	24	475,0

66631	90X90 cm	32	24	275,0
66620	100X90 cm	35	24	310,0
66622	120X90 cm	43	24	350,0
66624	140X90 cm	50	24	390,0
66626	160X90 cm	58	24	440,0
66628	180X90 cm	65	24	490,0
66629	200X90 cm	73	24	540,0

### + REPUESTOS Y ACCESORIOS

TN5020080000000	Válvula de desagüe ø90 mm. Altura 80 mm	25,0
TN5020120000000	Válvula de desagüe ø90 mm. Altura 60 mm	50,0

### + REPUESTOS Y ACCESORIOS

TN5020080000000	Válvula de desagüe ø90 mm. Altura 80 mm	25,0
TN5020120000000	Válvula de desagüe ø90 mm. Altura 60 mm	50,0



\* Nota: Referencias en stock. Consulte con el Departamento Comercial para otras medidas / acabados.

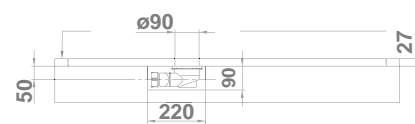
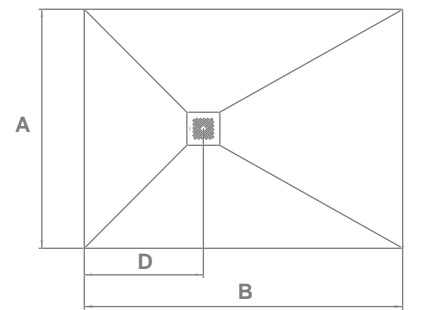
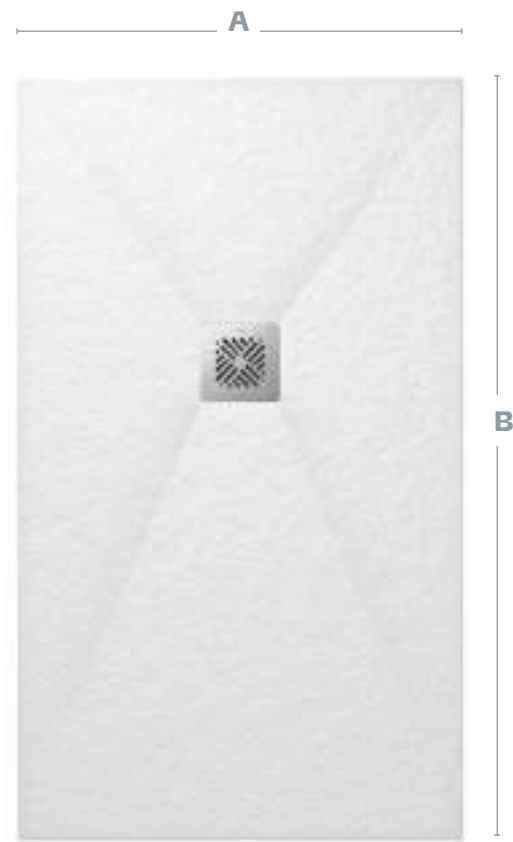

**PLATO QUANTUM**

	<b>B</b>	<b>A</b>	<b>D</b>
800x800	800	800	400*
900x900	900	900	400*
1000x700		700	
1000x800	1000	800	350
1000x900		900	
1100x700	1100	700	
1100x800		800	
1200x700		700	
1200x800	1200	800	
1200x900		900	
1300x700	1300	700	450
1300x800		800	
1400x700		700	
1400x800	1400	800	
1400x900		900	
1500x700	1500	700	
1500x800		800	
1600x700		700	
1600x800	1600	800	
1600x900		900	
1700x700	1700	700	550
1700x800		800	
1800x700		700	
1800x800	1800	800	
1800x900		900	
2000x800	2000	800	
2000x900		900	



\* Desagüe en el centro.

# Porcelana

Gyda **N**



angulares

**GYDA**  
80x80 cm

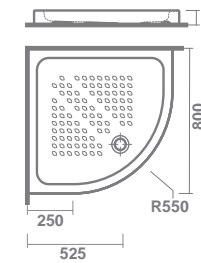

**GYDA**  
90x90 cm

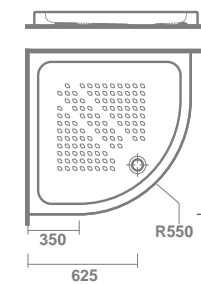

€/u

**GYDA**

8 cm de altura sin válvula de  
desagüe de 90 mm

10920	<b>80X80 cm</b>	26,5	13	150,0
10921	<b>90X90 cm</b>	33	13	185,0

**+ REPUESTOS Y ACCESORIOS**

€/u

TN5020180000000	Válvula de desagüe $\varnothing$ 90 mm con tapa cromada. Altura 80 mm.	30,0
-----------------	---	------

**Nota:** Los platos de ducha de porcelana se suministran sin válvula de desagüe y sin caja.

## cuadrados



**GYDA**  
70x70 cm

€/u

**GYDA**  
8 cm de altura sin válvula de  
desagüe de 90 mm

10922 **70X70 cm** 120,0

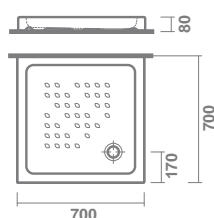

**GYDA**  
80x80 cm

€/u

**GYDA**  
8 cm de altura sin válvula de  
desagüe de 90 mm

10923 **80X80 cm** 150,0

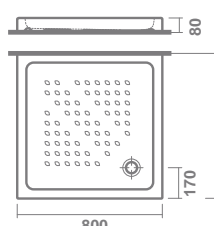

**GYDA**  
90x90 cm

€/u

**GYDA**  
8 cm de altura sin válvula de  
desagüe de 90 mm

10924 **90X90 cm** 180,0

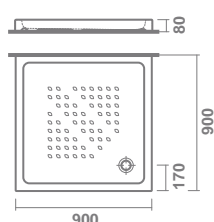

### REPUESTOS Y ACCESORIOS

TN5020180000000 Válvula de desagüe ø 90 mm con tapa cromada. Altura 80 mm. 30,0

**Nota:** Los platos de ducha de porcelana se suministran sin válvula de desagüe y sin caja.

## rectangulares



**GYDA**  
90x72 cm

€/u

**GYDA**  
8 cm de altura sin válvula de  
desagüe de 90 mm

10925 **90X72 cm** 150,0

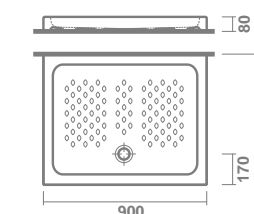

**GYDA**  
100x70 cm

€/u

**GYDA**  
8 cm de altura sin válvula de  
desagüe de 90 mm

10926 **100X70 cm** 190,0

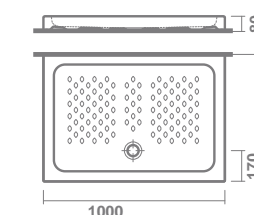

**GYDA**  
120x70 cm

€/u

**GYDA**  
8 cm de altura sin válvula de  
desagüe de 90 mm

10927 **120X70 cm** 245,0

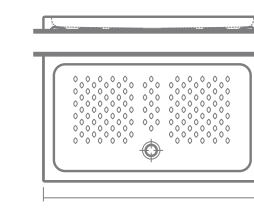

### REPUESTOS Y ACCESORIOS

TN5020180000000 Válvula de desagüe ø 90 mm con tapa cromada. Altura 80 mm. 30,0

**Nota:** Los platos de ducha de porcelana se suministran sin válvula de desagüe y sin caja.

# porcelana

## rectangulares



**GYDA**  
140x70 cm

**GYDA**  
8 cm de altura sin válvula de  
desagüe de 90 mm

10928 **140X70 cm** **330,0** €/u

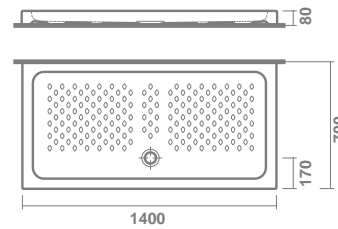

**GYDA**  
100x80 cm

**GYDA**  
8 cm de altura sin válvula de  
desagüe de 90 mm

10929 **100X80 cm** **245,0** €/u

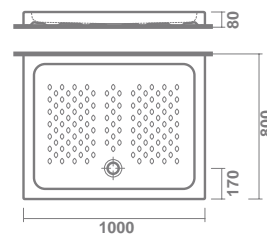

**GYDA**  
120x80 cm

**GYDA**  
8 cm de altura sin válvula de  
desagüe de 90 mm

10930 **120X80 cm** **260,0** €/u

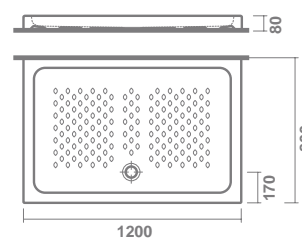

### REPUESTOS Y ACCESORIOS

TN5020180000000 Válvula de desagüe  $\varnothing$  90 mm con tapa cromada. Altura 80 mm. **30,0** €/u



**Nota:** Los platos de ducha de porcelana se suministran sin válvula de desagüe y sin caja.

**Nota:** Los platos de ducha de porcelana se suministran sin válvula de desagüe y sin caja.



# Acrílicos

Vita-N **N**



## Acabados



01  
Blanco liso



21  
Blanco texturizado



02  
Negro texturizado

### CARACTERÍSTICAS TÉCNICAS

- Fabricado mediante planchas acrílicas termoconformadas, reforzadas posteriormente con una placa de madera (sellada con fibra de vidrio y resina de poliéster).
- Tres acabados diferentes para adaptarse a todos los espacios de baño:
  - Blanco brillo con superficie lisa.
  - Blanco mate con superficie antideslizante con textura *Stone*.
  - Negro mate con superficie antideslizante con textura *Stone*.
- Altura de 4-5 cm que permite la instalación encastrada o posada.
- Marcado CE según la norma EN 14527.
- Instalación sencilla y práctica gracias a su peso reducido.
- Válvula de desagüe de gran caudal:  $\varnothing 90$  mm. (no incluida).
- 2 años de garantía.
- Platos de grandes dimensiones, ideales para crear el espacio de ducha sustituyendo la bañera.

## angulares

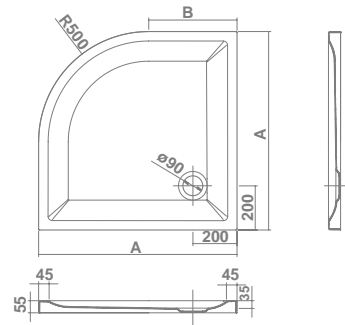

		€/u		
<b>VITA-N</b>				
5,5 cm de altura. Válvula de desagüe no incluida (tres acabados de tapa disponibles)				
6658501	<b>80x80x5,5 cm</b>			195,0
6658601	<b>90x90x5,5 cm</b>			235,0
6658701	<b>100x100x5,5 cm</b>			295,0

	A	B
800x800	800	300
900x900	900	400
1000x1000	1000	500

### + REPUESTOS Y ACCESORIOS

	€/u
TN5020180000000 Válvula de desagüe de $\varnothing$ 90 mm con tapa cromada. Altura 80 mm.	30,0
6803121 Válvula de desagüe extraplana de $\varnothing$ 90 mm con tapa blanco mate. Altura 60 mm.	60,0
6803102 Válvula de desagüe extraplana de $\varnothing$ 90 mm con tapa negro mate. Altura 60 mm	60,0

**Nota:** Los platos de ducha acrílicos se suministran con caja.

## angulares

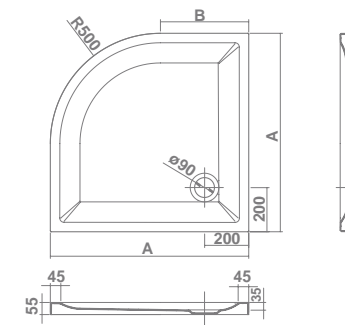

		€/u		
<b>VITA-N</b>				
5,5 cm de altura. Válvula de desagüe no incluida (tres acabados de tapa disponibles)				
66585	<b>80x80x5,5 cm</b>			225,0
	○ 21 blanco texturizado			225,0
	● 02 negro texturizado			225,0
66586	<b>90x90x5,5 cm</b>			265,0
	○ 21 blanco texturizado			265,0
	● 02 negro texturizado			265,0
66587	<b>100x100x5,5 cm</b>			335,0
	○ 21 blanco texturizado			335,0
	● 02 negro texturizado			335,0

	A	B
800x800	800	300
900x900	900	400
1000x1000	1000	500

### + REPUESTOS Y ACCESORIOS

	€/u
TN5020180000000 Válvula de desagüe de $\varnothing$ 90 mm con tapa cromada. Altura 80 mm.	30,0
6803121 Válvula de desagüe extraplana de $\varnothing$ 90 mm con tapa blanco mate. Altura 60 mm.	60,0
6803102 Válvula de desagüe extraplana de $\varnothing$ 90 mm con tapa negro mate. Altura 60 mm	60,0

**Nota:** Los platos de ducha acrílicos se suministran con caja.

## cuadrados

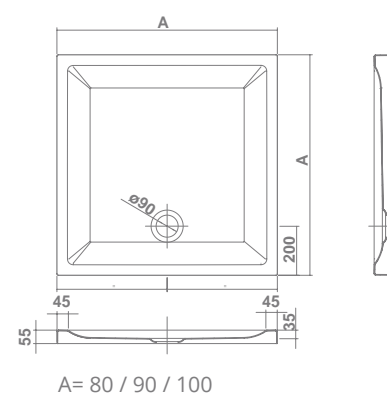

€/u

### VITA-N

5,5 cm de altura. Válvula de desagüe no incluida (tres acabados de tapa disponibles)

6658001 **80x80x5,5 cm**   185,0

6658101 **90x90x5,5 cm**   225,0

6658201 **100x100x5,5 cm**   285,0

## cuadrados

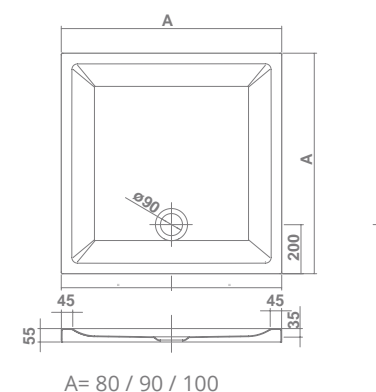

€/u

### VITA-N

5,5 cm de altura. Válvula de desagüe no incluida (tres acabados de tapa disponibles)



66580 **80x80x5,5 cm**

○ 21 blanco texturizado   215,0



● 02 negro texturizado   215,0

66581 **90x90x5,5 cm**

○ 21 blanco texturizado   255,0

● 02 negro texturizado   255,0

66582 **100x100x5,5 cm**

○ 21 blanco texturizado   325,0

● 02 negro texturizado   325,0

### + REPUESTOS Y ACCESORIOS

€/u

TN5020180000000	Válvula de desagüe de $\varnothing$ 90 mm con tapa cromada. Altura 80 mm.	30,0
6803121	Válvula de desagüe extraplana de $\varnothing$ 90 mm con tapa blanco mate. Altura 60 mm.	60,0
6803102	Válvula de desagüe extraplana de $\varnothing$ 90 mm con tapa negro mate. Altura 60 mm	60,0

Nota: Los platos de ducha acrílicos se suministran con caja.

### + REPUESTOS Y ACCESORIOS

€/u

TN5020180000000	Válvula de desagüe de $\varnothing$ 90 mm con tapa cromada. Altura 80 mm.	30,0
6803121	Válvula de desagüe extraplana de $\varnothing$ 90 mm con tapa blanco mate. Altura 60 mm.	60,0
6803102	Válvula de desagüe extraplana de $\varnothing$ 90 mm con tapa negro mate. Altura 60 mm	60,0

Nota: Los platos de ducha acrílicos se suministran con caja.

## rectangulares



# 70

### PLATO VITA-N A= 70cm

4-5 cm de altura.  
Válvula de desagüe no incluida  
(tres acabados de tapa disponibles)



# 80

### PLATO VITA-N A= 80cm

4-5 cm de altura.  
Válvula de desagüe no incluida  
(tres acabados de tapa disponibles)









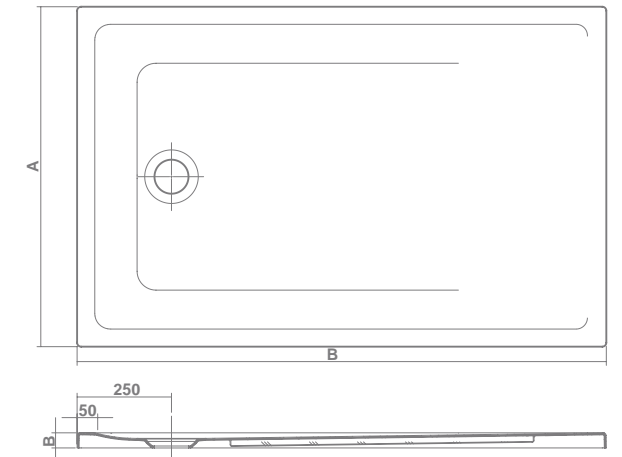



# 90

### PLATO VITA-N A= 90cm









4-5 cm de altura.  
Válvula de desagüe no incluida  
(tres acabados de tapa disponibles)



B= 100 / 110 / 120 / 130 / 140 / 150 / 160 / 170 / 180

	€/u
6655001 <b>100x70x4 cm</b>  	230,0
6655201 <b>120x70x4 cm</b>  	260,0
6655401 <b>140x70x4 cm</b>  	290,0
6655601 <b>160x70x5 cm</b>  	320,0
6655701 <b>170x70x5 cm</b>  	335,0

	€/u
6656001 <b>100x80x4 cm</b>  	245,0
6656101 <b>110x80x4 cm</b>  	265,0
6656201 <b>120x80x4 cm</b>  	280,0
6656301 <b>130x80x4 cm</b>  	300,0
6656401 <b>140x80x4 cm</b>  	315,0
6656501 <b>150x80x5 cm</b>  	335,0
6656601 <b>160x80x5 cm</b>  	350,0
6656701 <b>170x80x5 cm</b>  	370,0
6656801 <b>180x80x5 cm</b>  	385,0

	€/u
6657001 <b>100x90x4 cm</b>  	300,0
6657201 <b>120x90x4 cm</b>  	345,0
6657401 <b>140x90x4 cm</b>  	385,0
6657601 <b>160x90x5 cm</b>  	425,0

### + REPUESTOS Y ACCESORIOS

	€/u
TN5020180000000 Válvula de desagüe de <b>ø 90 mm</b> con tapa cromada. Altura 80 mm.	30,0
6803121 Válvula de desagüe extraplana de <b>ø 90 mm</b> con tapa blanco mate. Altura 60 mm.	60,0
6803102 Válvula de desagüe extraplana de <b>ø 90 mm</b> con tapa negro mate. Altura 60 mm.	60,0

Nota: Los platos de ducha acrílicos se suministran con caja.

### + REPUESTOS Y ACCESORIOS

	€/u
TN5020180000000 Válvula de desagüe de <b>ø 90 mm</b> con tapa cromada. Altura 80 mm.	30,0
6803121 Válvula de desagüe extraplana de <b>ø 90 mm</b> con tapa blanco mate. Altura 60 mm.	60,0
6803102 Válvula de desagüe extraplana de <b>ø 90 mm</b> con tapa negro mate. Altura 60 mm.	60,0

Nota: Los platos de ducha acrílicos se suministran con caja.





















## rectangulares



### PLATO VITA-N A= 70cm

4-5 cm de altura.  
Válvula de desagüe no incluida  
(tres acabados de tapa disponibles)

€/u

66550 <b>100x70x4 cm</b>		
○ 21 blanco texturizado	 	265,0
● 02 negro texturizado	 	265,0
66552 <b>120x70x4 cm</b>		
○ 21 blanco texturizado	 	300,0
● 02 negro texturizado	 	300,0
66554 <b>140x70x4 cm</b>		
○ 21 blanco texturizado	 	335,0
● 02 negro texturizado	 	335,0
66556 <b>160x70x5 cm</b>		
○ 21 blanco texturizado	 	370,0
● 02 negro texturizado	 	370,0
66557 <b>170x70x5 cm</b>		
○ 21 blanco texturizado	 	385,0
● 02 negro texturizado	 	385,0

### + REPUESTOS Y ACCESORIOS

€/u



































TN5020180000000	Válvula de desagüe de $\varnothing$ 90 mm con tapa cromada. Altura 80 mm.	30,0
6803121	Válvula de desagüe extraplana de $\varnothing$ 90 mm con tapa blanco mate. Altura 60 mm.	60,0
6803102	Válvula de desagüe extraplana de $\varnothing$ 90 mm con tapa negro mate. Altura 60 mm.	60,0



### PLATO VITA-N A= 80cm

4-5 cm de altura.  
Válvula de desagüe no incluida  
(tres acabados de tapa disponibles)

€/u

66560 <b>100x80x4 cm</b>		
○ 21 blanco texturizado	 	280,0
● 02 negro texturizado	 	280,0
66561 <b>110x80x4 cm</b>		
○ 21 blanco texturizado	 	305,0
● 02 negro texturizado	 	305,0
66562 <b>120x80x4 cm</b>		
○ 21 blanco texturizado	 	320,0
● 02 negro texturizado	 	320,0
66563 <b>130x80x4 cm</b>		
○ 21 blanco texturizado	 	340,0
● 02 negro texturizado	 	340,0
66564 <b>140x80x4 cm</b>		
○ 21 blanco texturizado	 	360,0
● 02 negro texturizado	 	360,0
66565 <b>150x80x5 cm</b>		
○ 21 blanco texturizado	 	385,0
● 02 negro texturizado	 	385,0
66566 <b>160x80x5 cm</b>		
○ 21 blanco texturizado	 	400,0
● 02 negro texturizado	 	400,0
66567 <b>170x80x5 cm</b>		
○ 21 blanco texturizado	 	420,0
● 02 negro texturizado	 	420,0
66568 <b>180x80x5 cm</b>		
○ 21 blanco texturizado	 	440,0
● 02 negro texturizado	 	440,0



### PLATO VITA-N A= 90cm

4-5 cm de altura.  
Válvula de desagüe no incluida  
(tres acabados de tapa disponibles)

€/u

66570 <b>100x90x4 cm</b>		
○ 21 blanco texturizado	 	350,0
● 02 negro texturizado	 	350,0
66572 <b>120x90x4 cm</b>		
○ 21 blanco texturizado	 	390,0
● 02 negro texturizado	 	390,0
66574 <b>140x90x4 cm</b>		
○ 21 blanco texturizado	 	435,0
● 02 negro texturizado	 	435,0
66576 <b>160x90x5 cm</b>		
○ 21 blanco texturizado	 	480,0
● 02 negro texturizado	 	480,0

### + REPUESTOS Y ACCESORIOS

€/u

TN5020180000000	Válvula de desagüe de $\varnothing$ 90 mm con tapa cromada. Altura 80 mm.	30,0
6803121	Válvula de desagüe extraplana de $\varnothing$ 90 mm con tapa blanco mate. Altura 60 mm.	60,0
6803102	Válvula de desagüe extraplana de $\varnothing$ 90 mm con tapa negro mate. Altura 60 mm.	60,0

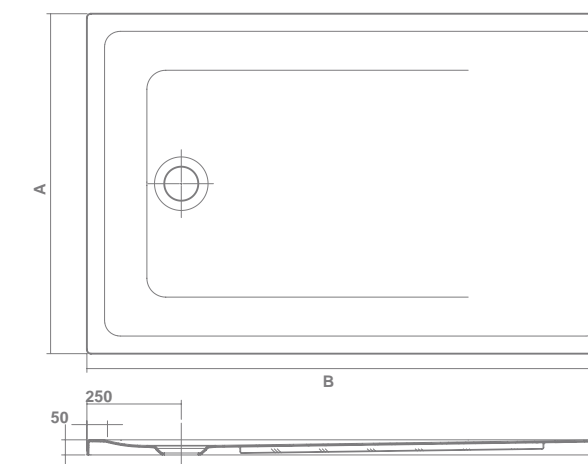

B= 100/110/120/130/140/150/160/170/180

Nota: Los platos de ducha acrílicos se suministran con caja.

Nota: Los platos de ducha acrílicos se suministran con caja.

# acrílicos



## gala-drain L



**GALA - DRAIN L**

	€/u		€/u
53400	<b>KIT DE DESAGÜE INTEGRADO*</b> 160,0	53402	<b>KIT DE DESAGÜE INTEGRADO*</b> 185,0
	de <b>65 cm</b> para la instalación de duchas de obra. Juego de desagüe y placa embellecedora lineales. Salida horizontal.		de <b>85 cm</b> para la instalación de duchas de obra. Juego de desagüe y placa embellecedora lineales. Salida horizontal.
53401	<b>KIT DE DESAGÜE INTEGRADO*</b> 170,0	53403	<b>KIT DE DESAGÜE INTEGRADO*</b> 200,0
	de <b>75 cm</b> para la instalación de duchas de obra. Juego de desagüe y placa embellecedora lineales. Salida horizontal.		de <b>95 cm</b> para la instalación de duchas de obra. Juego de desagüe y placa embellecedora lineales. Salida horizontal.

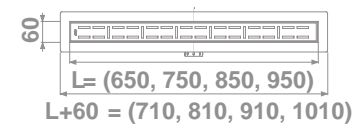
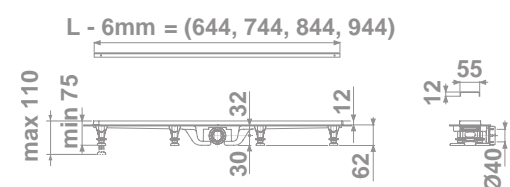

\* Disponible hasta fin de existencias.

## gala-drain SQ

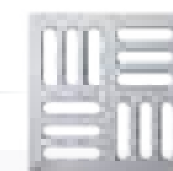

**GALA - DRAIN SQ**

	€/u
53404	<b>KIT DE DESAGÜE INTEGRADO*</b> 80,0
	de <b>10,5 cm</b> para la instalación de duchas de obra. Juego de desagüe y placa embellecedora cuadrados. Salida horizontal.

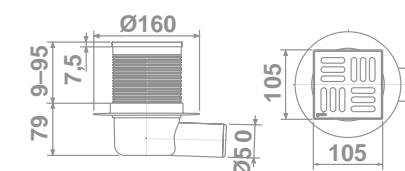

### + REPUESTOS Y ACCESORIOS

	€/u
53405	Manta impermeabilizante de <b>200x150 cm</b> para gala-drain* 60,0



\* Disponible hasta fin de existencias.

# mamparas





# K l e v a n

Mamparas



## Modelos

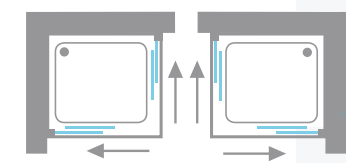

**2 paredes**  
(entrada en vértice)

Cuadrados o rectangulares



**2 paredes**

Para platos rectangulares

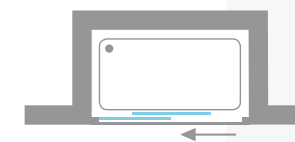

**3 paredes**  
(2 hojas)

Mampara frontal

### CARACTERÍSTICAS TÉCNICAS

- Mampara sin perfilera inferior.
- Diseño moderno a base de líneas rectas y perfiles a pared minimalistas.
- Colgador de diseño incorporado.
- Instalación dual a elegir: atornillada y pegada a pared.
- Cristales templados de seguridad de 6 mm en todas las hojas.
- Cristal transparente.
- Tratamiento easy-clean\* en todos los cristales.
- Perfilera en aluminio anodizado con acabado en plata brillo.
- Puertas correderas con rodamientos ocultos y sistema de fácil extracción para limpieza.
- Ajustable a medida.
- Cumplimento de normativa: UNE-EN: 14428:2005.
- Altura: 195 cm

**Nota:** \* Easy-clean es un tratamiento antical, no un tratamiento de autolimpieza, por lo que recomendamos una limpieza regular de su mampara siguiendo los consejos de mantenimiento de Gala.

**klevan V**

**Mampara con entrada por el vértice**  
 Altura 195 cm  
 Para platos cuadrados o rectangulares  
 Instalación entre 2 paredes.

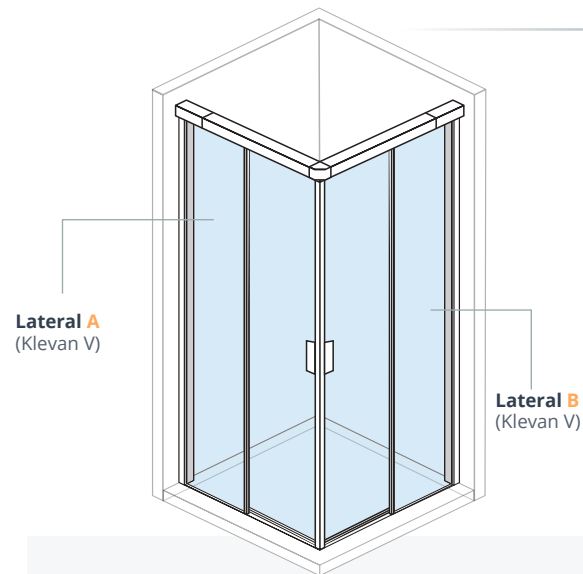

**Lateral A**  
 (1 segmento fijo + 1 puerta corredera)  
 +  
**Lateral B**  
 (1 segmento fijo + 1 puerta corredera)\*



	€/u		€/u
89300 MAMPARA LATERAL KLEVAN V DE 70 cm	325,0	89305 MAMPARA LATERAL KLEVAN V DE 100 cm	400,0
89302 MAMPARA LATERAL KLEVAN V DE 80 cm	350,0	89307 MAMPARA LATERAL KLEVAN V DE 120 cm	430,0
89304 MAMPARA LATERAL KLEVAN V DE 90 cm	375,0		



\* Es necesario solicitar dos referencias, correspondientes a cada lado de la mampara (A y B). Mamparas reversibles (no es necesario especificar la mano).

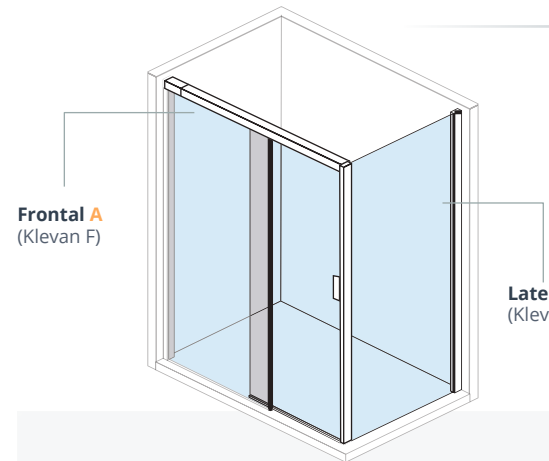

**Frontal A**  
(Klevan F)

**Lateral Fijo B**  
(Klevan LF)

### Klevan F + LF

Instalación entre 2 paredes  
Mampara rectangular  
Para platos rectangulares

**Frontal A**  
(1 segmento fijo + 1 puerta corredera)

+

**Lateral Fijo Klevan LF B\***

**F**

€/u

89308	MAMPARA FRONTAL KLEVAN F DE 100 cm	37	12	450,0		89312	MAMPARA FRONTAL KLEVAN F DE 140 cm	51	12	510,0
89309	MAMPARA FRONTAL KLEVAN F DE 110 cm	40	12	465,0		89313	MAMPARA FRONTAL KLEVAN F DE 150 cm	54	12	525,0
89310	MAMPARA FRONTAL KLEVAN F DE 120 cm	44	12	480,0		89314	MAMPARA FRONTAL KLEVAN F DE 160 cm	57	12	540,0
89311	MAMPARA FRONTAL KLEVAN F DE 130 cm	47	12	495,0						

+

**LF**

€/u

89315	LATERAL FIJO KLEVAN LF DE 70 cm	24	16	290,0		89316	LATERAL FIJO KLEVAN LF DE 80 cm	27	16	305,0
-------	---------------------------------	----	----	-------	--	-------	---------------------------------	----	----	-------



\* Es necesario solicitar dos referencias, correspondientes a cada lado de la mampara (F y LF).  
Mamparas reversibles (no es necesario especificar la mano)

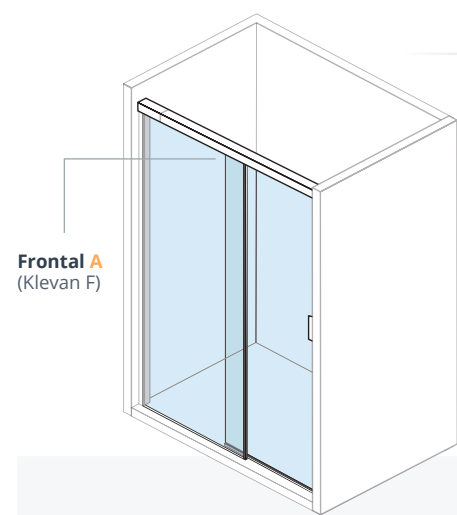

**klevan F**

Instalación entre 3 paredes  
Mampara frontal

Frontal A  
(Klevan F)

**Frontal A**  
(1 segmento fijo + 1 puerta corredera)

F

	€/u		€/u
89308 MAMPARA FRONTAL KLEVAN F DE 100 cm	37 12 450,0	89312 MAMPARA FRONTAL KLEVAN F DE 140 cm	51 12 510,0
89309 MAMPARA FRONTAL KLEVAN F DE 110 cm	40 12 465,0	89313 MAMPARA FRONTAL KLEVAN F DE 150 cm	54 12 525,0
89310 MAMPARA FRONTAL KLEVAN F DE 120 cm	44 12 480,0	89314 MAMPARA FRONTAL KLEVAN F DE 160 cm	57 12 540,0
89311 MAMPARA FRONTAL KLEVAN F DE 130 cm	47 12 495,0		



Mamparas reversibles (no es necesario especificar la mano).

**new step bañera\***

**Mampara para bañera**  
(Frontal de **1 hoja** batiente)  
Altura 150 cm



€/u

89440 **FRONTAL BAÑERA 1 HOJA NEW STEP 90cm**  **325,0**

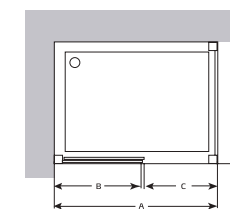

Para platos rectangulares

Descripción	Referencia	Tolerancia A	Medida B	Medida puerta C (Min / Max)	Medida D (Min / Max)
-------------	------------	--------------	----------	-----------------------------	----------------------

**2 PAREDES (rectangular)**

**MAMPARA FRONTAL KLEVAN F**

Klevan F 100 cm	8930800	960 mm / 1060 mm	515 mm	Mín. 360 mm / Máx. 460 mm	-
Klevan F 110 cm	8930900	1061 mm / 1160 mm	565 mm	Mín. 410 mm / Máx. 510 mm	-
Klevan F 120 cm	8931000	1161 mm / 1260 mm	615 mm	Mín. 460 mm / Máx. 560 mm	-
Klevan F 130 cm	8931100	1261 mm / 1360 mm	665 mm	Mín. 510 mm / Máx. 610 mm	-
Klevan F 140 cm	8931200	1361 mm / 1460 mm	715 mm	Mín. 560 mm / Máx. 660 mm	-
Klevan F 150 cm	8931300	1461 mm / 1560 mm	765 mm	Mín. 610 mm / Máx. 710 mm	-
Klevan F 160 cm	8931400	1561 mm / 1660 mm	815 mm	Mín. 660 mm / Máx. 760 mm	-

**LATERAL FIJO KLEVAN LF**

Klevan LF 70 cm	8931500	-	-	-	Mín. 670 mm Máx. 705 mm
Klevan LF 80 cm	8931600	-	-	-	Mín. 770 mm Máx. 805 mm

Descripción	Referencia	Tolerancia A	Medida B	Medida puerta C
-------------	------------	--------------	----------	-----------------

**3 PAREDES (2 hojas)**

**MAMPARA FRONTAL KLEVAN F**

Klevan F 100 cm	8930800	960 mm / 1060 mm	515 mm	Mín. 360 mm. Máx. 460 mm
Klevan F 110 cm	8930900	1061 mm / 1160 mm	565 mm	Mín. 410 mm. Máx. 510 mm
Klevan F 120 cm	8931000	1161 mm / 1260 mm	615 mm	Mín. 460 mm. Máx. 560 mm
Klevan F 130 cm	8931100	1261 mm / 1360 mm	665 mm	Mín. 510 mm. Máx. 610 mm
Klevan F 140 cm	8931200	1361 mm / 1460 mm	715 mm	Mín. 560 mm. Máx. 660 mm
Klevan F 150 cm	8931300	1461 mm / 1560 mm	765 mm	Mín. 610 mm. Máx. 710 mm
Klevan F 160 cm	8931400	1561 mm / 1660 mm	815 mm	Mín. 660 mm. Máx. 760 mm

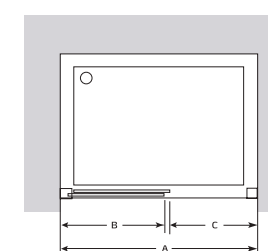

Descripción	Referencia	Tolerancia A	Medida B
-------------	------------	--------------	----------

**new step bañera**

**FRONTAL BAÑERA 1 HOJA**

Frontal bañera 1 hoja 90 cm	8944000	895 mm / 905 mm	850 mm
-----------------------------	---------	-----------------	--------

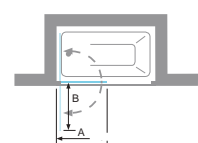

\* En venta hasta fin de existencias.

guía rápida Klevan

Descripción	Referencia	Tolerancia A	Medida B	Medida puerta C (Medidas más comunes de instalación*)
-------------	------------	--------------	----------	---

**2 PAREDES (entrada en vértice)**

**MAMPARA LATERAL KLEVAN V**

Klevan V 70 cm	8930000	670 mm / 720 mm	345 mm	*700x700 mm	Mín. 340 mm / Máx. 410 mm
Klevan V 80 cm	8930200	771 mm / 820 mm	395 mm	*800x800 mm	Mín. 410 mm / Máx. 480 mm
Klevan V 90 cm	8930400	871 mm / 970 mm	470 mm	*900x900 mm	Mín. 440 mm / Máx. 585 mm
Klevan V 100 cm	8930500	971 mm / 1070 mm	520 mm	*1000x700 mm	Mín. 435 mm / Máx. 545 mm
				*1000x750 mm	Mín. 450 mm / Máx. 560 mm
				*1000x800 mm	Mín. 460 mm / Máx. 575 mm
Klevan V 120 cm	8930700	1171 mm / 1270 mm	620 mm	*1200x700 mm	Mín. 520 mm / Máx. 630 mm
				*1200x750 mm	Mín. 530 mm / Máx. 640 mm
				*1200x800 mm	Mín. 545 mm / Máx. 655 mm

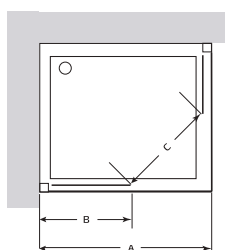

Para platos cuadrados o rectangulares

\* Consultar para el resto de medidas.

# bañeras





# bañeras

índice

GUÍAS RÁPIDAS

420

BAÑERAS

SISTEMAS DE HIDROMASAJE

426

SISTEMAS DE  
HIDROMASAJE:  
AGUA

428

SISTEMAS DE  
HIDROMASAJE:  
AGUA + AIRE

ACRÍLICAS

430

ACRÍLICAS  
RECTANGULARES

Mid  
Flex Center  
Emma  
Mitta  
Nila

468

ACRÍLICAS  
ANGULARES

Flex Center  
Trevo

480

ACRÍLICA  
CIRCULAR

Omega

ACERO

484

BAÑERAS  
DE ACERO



Ópera  
Vanessa  
Fedra  
Gala

# guía rápida

bañeras rectangulares

		LONGITUD en CM								
		Ancho	105	120	130	140	150	160	170	180
<b>GALA</b> acero		70 cm	502-503	502-503	502-503	502-503	502-503	502-503	502-503	
<b>FEDRA</b> acero						498-499	498-499	498-499	498-499	
<b>MITTA</b> acrílica						454-463	454-463	454-463	454-463	
<b>NILA</b> acrílica						466 - 467	466 - 467	466 - 467	466 - 467	
<b>MID</b> acrílica		73,7 cm							432-433	
<b>VANESA</b> acero		75 cm					494-495	494-495	494-495	
<b>EMMA</b> acrílica								442- 447	442 - 447	
<b>MITTA</b> acrílica								454-463	454-463	
<b>NILA</b> acrílica								466 - 467	466 - 467	
<b>ÓPERA</b> acero		80 cm (*)								487-491
<b>EMMA</b> acrílica									442-447	448 - 451
<b>MITTA</b> acrílica								454-463	454-463	454-463
<b>FLEX CENTER</b> acrílica		100 cm								436-439

bañeras angulares

		LONGITUD en CM		
		Ancho	135	160
<b>FLEX CENTER</b> acrílica		135 cm	470-473	
<b>TREVO</b> acrílica			476-479	
<b>OMEGA</b> acero		160 cm		481-483



## SISTEMAS DE HIDROMASAJE

BAÑERAS

	Emotive Essential	Emotive Touch	Emotive Touch Dorsal	Emotive Flex Center	Sensitive Touch	Sensitive Flex Center
Flex Center 180x100				<u>65580</u> p. 438		<u>65590</u> p. 439
Flex Center 180x100 con faldón				<u>65581</u> <u>65582</u> p. 438		<u>65591</u> <u>65592</u> p. 439
Emma 160x75		<u>64432</u> p. 446	<u>64435</u> p. 446		<u>64438</u> p. 447	
Emma 170x75		<u>64332</u> p. 446	<u>64335</u> p. 446		<u>64338</u> p. 447	
Emma 170x80		<u>64232</u> p. 446	<u>64235</u> p. 446		<u>64238</u> p. 447	
Emma 180x80		<u>64132</u> p. 450	<u>64135</u> p. 450		<u>64138</u> p. 451	
Mitta 140x70	<u>62833</u> p. 458	<u>62834</u> p. 460				
Mitta 150x70	<u>62933</u> p. 458	<u>63934</u> p. 460				
Mitta 160x70	<u>62711</u> p. 458	<u>62712</u> p.460	<u>62713</u> p. 460		<u>62714</u> p. 462	
Mitta 170x70	<u>62611</u> p.458	<u>62612</u> p. 460	<u>62613</u> p. 460		<u>62614</u> p. 462	
Mitta 160x75		<u>62513</u> p. 460	<u>62514</u> p. 460		<u>62515</u> p. 462	
Mitta 170x75		<u>62412</u> p. 460	<u>62413</u> p. 460		<u>62414</u> p. 462	
Mitta 160x80		<u>62564</u> p. 460	<u>62565</u> p. 460		<u>62566</u> p. 462	
Mitta 170x80		<u>62485</u> p. 460	<u>62486</u> p. 460		<u>62487</u> p. 462	
Mitta 180x80		<u>62675</u> p. 460	<u>62676</u> p.460		<u>62677</u> p. 462	

## SISTEMAS DE HIDROMASAJE

BAÑERAS

	Emotive Touch	Emotive Touch Dorsal	Emotive Flex Center	Sensitive Touch	Sensitive Flex Center
Flex Center 135x135			<u>65548</u> p. 472		<u>65549</u> p. 473
Flex Center 135x135 con faldón			<u>65552</u> p. 472		<u>65553</u> p. 473
Trevo 135x135	<u>61983</u> p. 478	<u>61984</u> p. 478		<u>61985</u> p. 479	
Omega 160	<u>68781</u> p. 483			<u>68783</u> p. 483	

## Hidromasaje agua: EMOTIVE

**Emotive Essential**

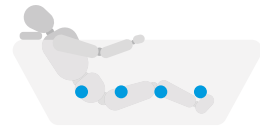

**Emotive Touch**

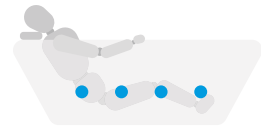

**Emotive Touch Dorsal**



**Emotive Flex Center**



Pulsador / Accionamiento	Pulsador neumático	Pulsador electrónico	Pulsador electrónico	Pulsador electrónico
Jets laterales	6	6	6	4
Jets dorsales / lumbares			4	3
Jets plantares				2 - 3
Jets de fondo (aire)				
Regulador de intensidad	■	■	■	■
Sensor de nivel		■	■	■
Válvula automática	■	■	■	■
Reposacabezas			1	2
Equipamiento extra				

## Hidromasaje agua + aire: SENSITIVE

**Sensitive Touch**



**Sensitive Flex Center**



Pulsador / Accionamiento	2 pulsadores electrónicos	2 pulsadores electrónicos
Jets laterales	6	4
Jets dorsales / lumbares		3
Jets plantares		2 - 3
Jets de fondo (aire)	8	8 - 12
Regulador de intensidad	■	■
Sensor de nivel	■	■
Válvula automática	■	■
Reposacabezas		2
Equipamiento extra		

## hidromasaje de agua **emotive**

Emotive es adentrarte en un sugerente spa privado, gracias a los jets de agua de los laterales de la bañera. Con solo accionar su pulsador, da comienzo un suave hidromasaje por todo el cuerpo con agua sobreoxigenada por aire a presión. Sus jets orientables crean un placentero masaje totalmente ajustable para una mayor comodidad, suavidad o profundidad oxigenando la piel, relajando los músculos y mejorando nuestra circulación.

# 01

### EMOTIVE ESSENTIAL

Seis jets regulables al alcance de la mano para un hidromasaje único por su relación calidad-precio.



Pulsador neumático    Jets laterales    Regulador intensidad    Válvula incluida

# 02

### EMOTIVE FLEX CENTER

Emotive Flex Center incorpora reposacabezas y jets plantares/dorsales integrados creando un nivel superior de confort y relajación para sumergir cuerpo y mente en un hidromasaje aún más pleno.



Pulsador electrónico    Jets laterales    Jets dorsales    Jets plantares    Regulador intensidad    Sensor de nivel    Válvula incluida    Reposacabezas

# 03

### EMOTIVE TOUCH

Una tecnología aún más cómoda para una mayor relajación, gracias a su pulsador electrónico y su sensor de nivel.



Pulsador electrónico    Jets laterales    Regulador intensidad    Sensor de nivel    Válvula incluida

### EMOTIVE TOUCH DORSAL

Más para los que quieren más: 4 jets dorsales rotatorios y reposacabezas para un masaje corporal extra relajante.



Pulsador electrónico    Jets laterales    Jets dorsales    Regulador intensidad    Sensor de nivel    Válvula incluida    Reposacabezas

## hidromasaje de agua+aire **sensitive**

Sensitive combina los beneficios del hidromasaje por agua con la envolvente sensación del masaje de aire. Fuerza y delicadeza al mismo tiempo para una mayor sensación de flotabilidad del cuerpo. Mientras los jets de agua sobreoxigenada con aire a presión penetran con más intensidad en piel y músculos, jets de aire en el fondo de la bañera proporcionan una agradable ingravidez que relaja más el cuerpo y la mente. Agua y aire, presión y ligereza, todo distribuido uniformemente para acertar en cada punto clave de cuello, riñones, piernas, brazos y espalda, creando un ambiente de hidroterapia ideal para un spa de lujo en casa.



# 01



### **SENSITIVE TOUCH**

Seis jets laterales de agua y 8 jets de aire en el fondo para alcanzar una sensación de bienestar en estado puro en cada punto clave del cuerpo.



# 02



### **SENSITIVE FLEX CENTER**

Sumergirse en un relajante masaje es aún más fácil con dos pulsadores de agua y aire que controlan jets laterales, dorsales, plantares y de fondo con tan solo un toque de mano.



acrílicas rectangulares

**M i d**





### CARACTERÍSTICAS TÉCNICAS

- Bañera exenta para instalación en isla.
- Faldón integrado (one piece).
- Grandes dimensiones: 170x73,7 cm
- Altura cubeta: 43 cm
- Altura total bañera: 54 cm
- Desagüe automático de 52 mm

## Mid exenta

acrílica rectangular



€/u

60001 **MID EXENTA** 2.575,0  
De 170x73,7 cm, con desagüe automático.

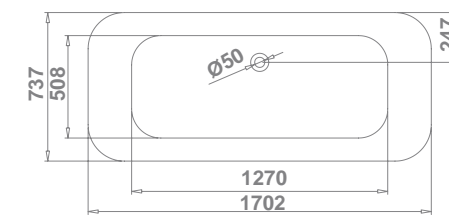
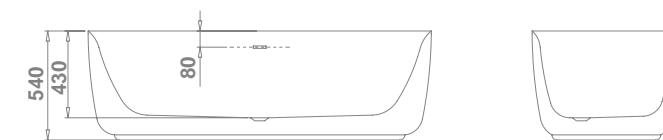

BAÑERAS

# Flex Center





### CARACTERÍSTICAS TÉCNICAS

- Posibilidad de instalación con murete o con bastidor autoportante y faldón en L negro.
- Grandes dimensiones: 180x100.
- Altura cubeta: 42 cm
- Altura bañera con faldón: 60 cm
- Desagüe automático de 52 mm y rebosadero ocultos.
- Reposacabezas integrados.
- Sistemas de hidromasaje Flex Center: máxima calidad y confort.

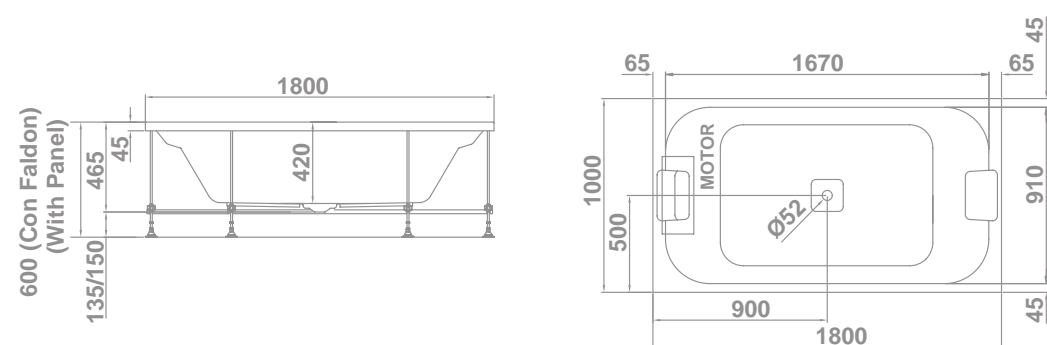

## Flex Center

acrílica rectangular



65,9	1	€/u
65570	<b>SIN FALDÓN</b>	1.455,0

65,9	1	€/u
<b>CON FALDÓN</b> Faldón especial tipo "L" color negro (frontal + lateral).		
65571	<b>FALDÓN MANO IZQUIERDA</b>	2.140,0
65572	<b>FALDÓN MANO DERECHA</b>	2.140,0

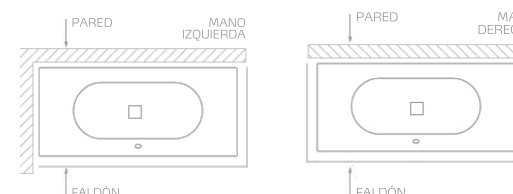

<b>+ FALDONES</b>		€/u
6740702	<b>FALDÓN "L" NEGRO DCHA</b>	785,0
6740802	<b>FALDÓN "L" NEGRO IZQ</b>	785,0

**Nota:** La bañera incluye bastidor, desagüe y 2 reposacabezas.



# Emotive Flex Center

bañera hidromasaje agua



65,9 1 €/u

65580 **SIN FALDÓN** 4.095,0  
 galaVIP Pulsador electrónico, regulador de intensidad, sonda de nivel y jets lumbares/plantares.

65,9 1 €/u

**CON FALDÓN**  
 Faldón especial tipo "L" color negro (frontal + lateral). Pulsador electrónico, regulador de intensidad, sonda de nivel y jets lumbares/plantares.

65581 **FALDÓN MANO IZQUIERDA** 4.750,0  
 galaVIP

65582 **FALDÓN MANO DERECHA** 4.750,0  
 galaVIP

# Sensitive Flex Center

bañera hidromasaje agua + aire



65,9 1 €/u

65590 **SIN FALDÓN** 5.275,0  
 galaVIP Pulsador electrónico, regulador de intensidad masajes agua y aire, sonda de nivel y jets lumbares/plantares.

65,9 1 €/u

**CON FALDÓN**  
 Faldón especial tipo "L" color negro (frontal + lateral). Pulsador electrónico, regulador de intensidad masajes agua y aire, sonda de nivel y jets lumbares/plantares.

65591 **FALDÓN MANO IZQUIERDA** 5.635,0  
 galaVIP

65592 **FALDÓN MANO DERECHA** 5.635,0  
 galaVIP

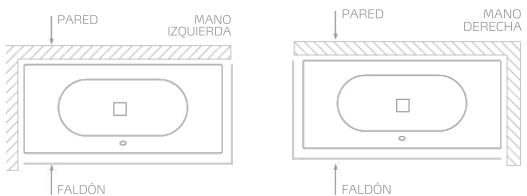

+		FALDONES	€/u
6740702	<b>FALDÓN "L" NEGRO DCHA</b>	785,0	
6740802	<b>FALDÓN "L" NEGRO IZQ</b>	785,0	

Nota: La bañera de hidromasaje lleva incorporados bastidor y desagüe automático.

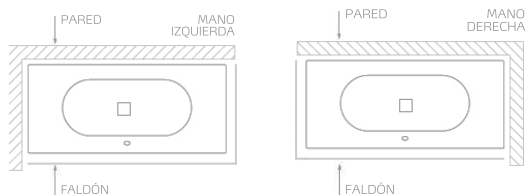

+		FALDONES	€/u
6740702	<b>FALDÓN "L" NEGRO DCHA</b>	785,0	
6740802	<b>FALDÓN "L" NEGRO IZQ</b>	785,0	

Nota: La bañera de hidromasaje lleva incorporados bastidor y desagüe automático.

acrílicas rectangulares

# Emma





REPOSACABEZAS



REGULADOR INTENSIDAD  
EMOTIVE TOUCH



MANDO SENSITIVE SMART

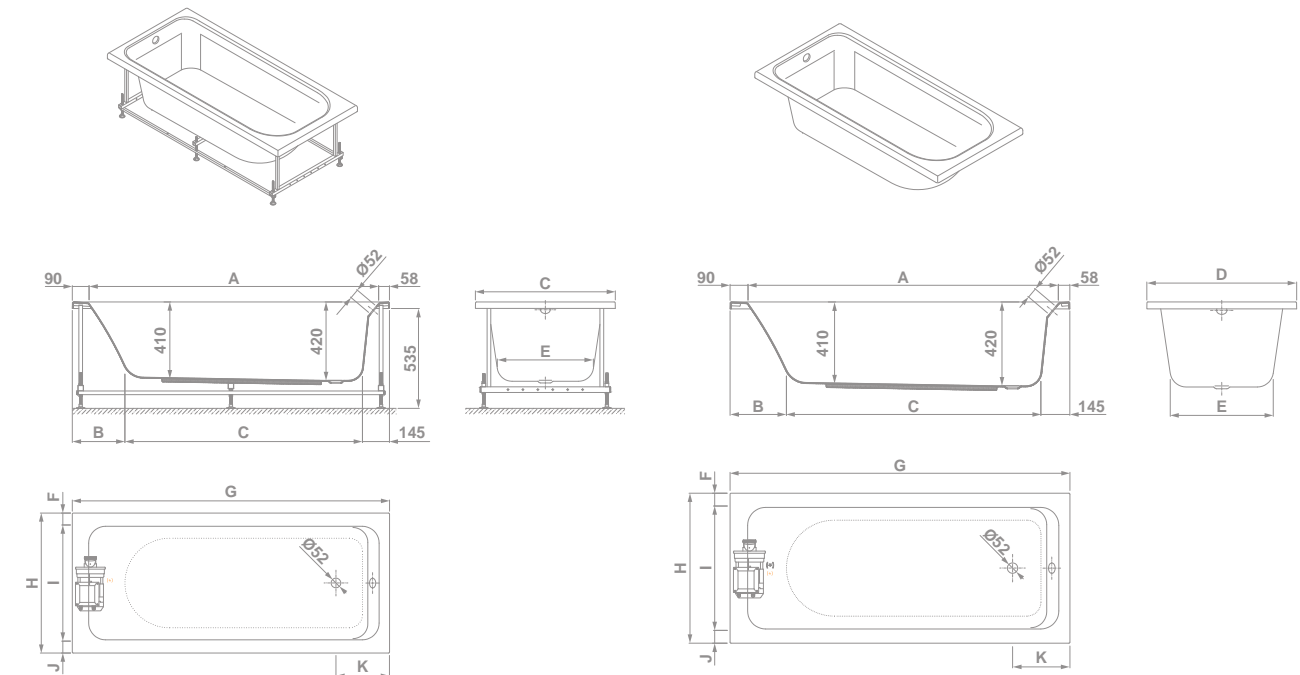

	A	B	C	D	E	F	G	H	I	J	K
<b>160x75 cm</b>	14,52	28,5	11,70	75	51,5	64	160	75	62,2	6,4	28
<b>170x75 cm</b>	15,52	28,2	12,73	75	51,5	64	170	75	62,2	6,4	28,7
<b>170x80 cm</b>	15,52	28,2	12,73	80	56,5	71	170	80	65,8	7,1	28,7

### CARACTERÍSTICAS TÉCNICAS

- Posibilidad de instalación con murete o con bastidor autoportante y faldón en "L".
- Altura cubeta: 42 cm
- Altura bañera con bastidor: 53,5 cm
- Desagüe de 52 mm
- Reposacabezas (opcional).

(\*) Sólo disponible en sistemas de hidromasaje

# Emma

acrílica rectangular



			€/u
<b>SIMPLE EMMA SIN BASTIDOR</b>			
64401	<b>160x75 cm</b>	 	315,0
64301	<b>170x75 cm</b>	 	315,0
64201	<b>170x80 cm</b>	 	400,0

			€/u
<b>SIMPLE EMMA CON BASTIDOR</b> Con desagüe automático. Autoportante.			
64404	<b>160x75 cm</b>	 	560,0
64304	<b>170x75 cm</b>	 	560,0
64204	<b>170x80 cm</b>	 	690,0

## + FALDOMES

		€/u	
<b>FALDÓN "L" IZQ</b>		<b>FALDÓN "L" DCHA</b>	
67445	<b>160x75 cm</b>	455,0	67446 <b>160x75 cm</b>
67447	<b>170x75 cm</b>	460,0	67448 <b>170x75 cm</b>
67449	<b>170x80 cm</b>	495,0	67450 <b>170x80 cm</b>

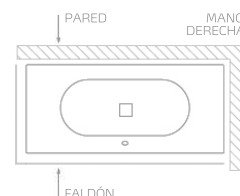
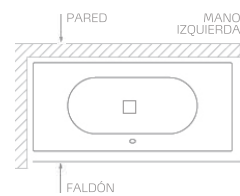

## + REPUESTOS Y ACCESORIOS

		€/u
41714	<b>DESAGÜE AUTOMÁTICO PARA BAÑERAS EMMA SIN HIDROMASAJE</b>	69,3
<b>CONJUNTO BASTIDOR AUTOPORTANTE</b>		
41219	<b>160x75 cm</b>	174,0
41220	<b>170x75 cm</b>	176,0
41221	<b>170x80 cm</b>	182,0

# Emotive Emma

bañera hidromasaje agua

# Sensitive Emma

bañera hidromasaje agua + aire



€/u

**EMOTIVE TOUCH**

Pulsador electrónico, regulador de intensidad y sonda de nivel.

64432	<b>160x75 cm</b>			1.680,0
64332	<b>170x75 cm</b>			1.680,0
64232	<b>170x80 cm</b>			1.680,0

€/u

**EMOTIVE TOUCH DORSAL**

Pulsador electrónico, regulador de intensidad, sonda de nivel, jets dorsales y reposacabezas.

64435	<b>160x75 cm</b>			2.205,0
64335	<b>170x75 cm</b>			2.205,0
64235	<b>170x80 cm</b>			2.275,0

€/u

**SENSITIVE TOUCH**

Pulsador electrónico, regulador de intensidad masaje agua y sonda de nivel.

64438	<b>160x75 cm</b>			2.910,0
64338	<b>170x75 cm</b>			2.910,0
64238	<b>170x80 cm</b>			3.000,0

**+ FALDONES**

€/u

**FALDÓN "L" IZQ**

67445	<b>160x75 cm</b>	455,0
67447	<b>170x75 cm</b>	460,0
67449	<b>170x80 cm</b>	495,0

**FALDÓN "L" DCHA**

67446	<b>160x75 cm</b>	455,0
67448	<b>170x75 cm</b>	460,0
67450	<b>170x80 cm</b>	495,0

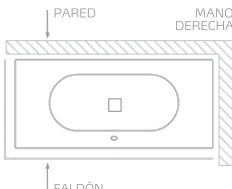
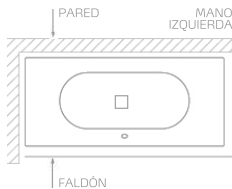

**+ FALDONES**

€/u

**FALDÓN "L" IZQ**

67445	<b>160x75 cm</b>	455,0
67447	<b>170x75 cm</b>	460,0
67449	<b>170x80 cm</b>	495,0

**FALDÓN "L" DCHA**

67446	<b>160x75 cm</b>	455,0
67448	<b>170x75 cm</b>	460,0
67450	<b>170x80 cm</b>	495,0

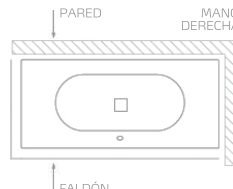
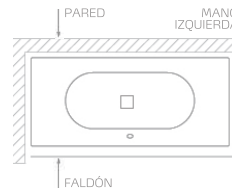

Nota: La bañera con hidromasaje lleva incorporados bastidor y desagüe automático.

Nota: La bañera con hidromasaje lleva incorporados bastidor y desagüe automático.



# Emma 180

acrílica rectangular



			€/u
<b>SIMPLE EMMA SIN BASTIDOR</b>			
64101	<b>180x80 cm</b>	 	430,0
<b>SIMPLE EMMA CON BASTIDOR</b> Con desagüe automático. Autoportante.			
64104	<b>180x80 cm</b>	 	700,0

## CARACTERÍSTICAS TÉCNICAS

- Posibilidad de instalación con murete o con bastidor autoportante y faldón en "L".
- Altura cubeta: 41 cm
- Altura bañera con bastidor: 53,5 cm con desagüe y rebosadero centrados.
- Desagüe de 52 mm
- Reposacabezas (opcional).

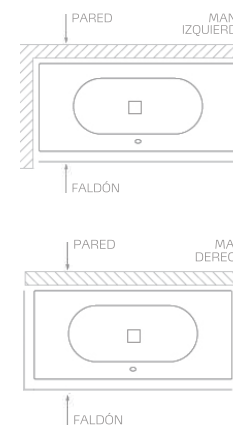
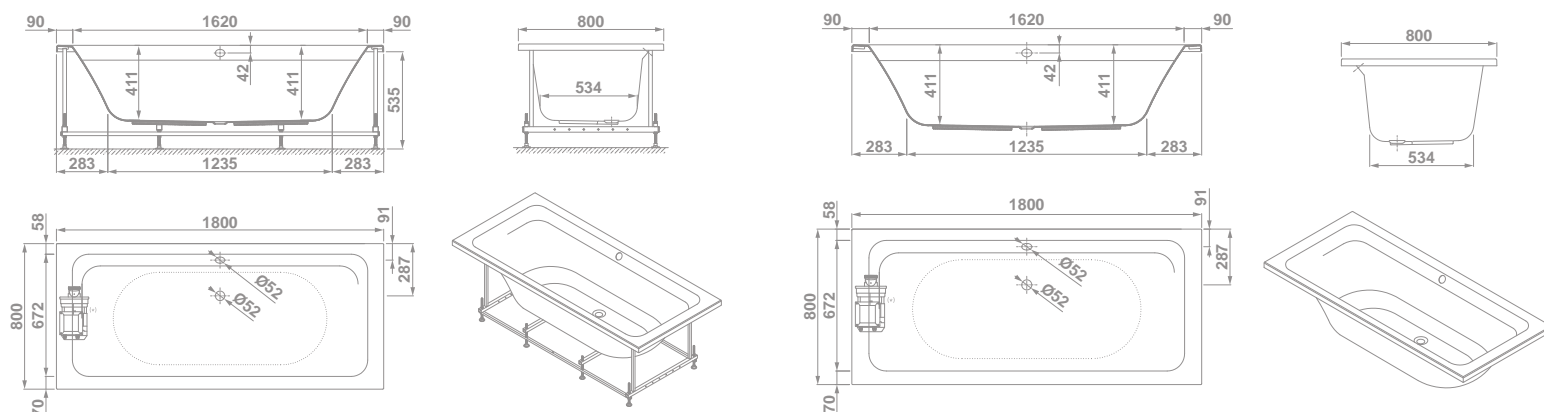

## + FALDONES

67451	<b>FALDÓN "L" IZQ</b> <b>180x80 cm</b>	540,0
67452	<b>FALDÓN "L" DCHA</b> <b>180x80 cm</b>	540,0

## + REPUESTOS Y ACCESORIOS

41714	<b>DESAGÜE AUTOMÁTICO PARA BAÑERAS EMMA SIN HIDROMASAJE</b>	69,3
41222	<b>CONJUNTO BASTIDOR AUTOPORTANTE</b> <b>180x80 cm</b>	188,0

(\*) Sólo disponible en sistemas de hidromasaje.

## Emotive Emma 180

bañera hidromasaje agua



€/u

### EMOTIVE TOUCH

Pulsador electrónico, regulador de intensidad y sonda de nivel

64132 **180x80 cm**   2.150,0

galaVIP

€/u

### EMOTIVE TOUCH DORSAL

Pulsador electrónico, regulador de intensidad, sonda de nivel, jets dorsales y reposacabezas

64135 **180x80 cm**   2.550,0

galaVIP

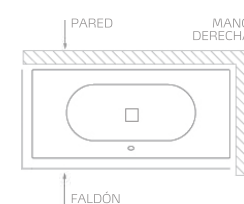
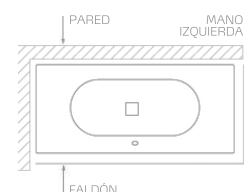

### + FALDONES

€/u

67451 **FALDÓN "L" IZQ** 540,0  
**180x80 cm**

67452 **FALDÓN "L" DCHA** 540,0  
**180x80 cm**

### + REPUESTOS Y ACCESORIOS

€/u

41714 **DESAGÜE AUTOMÁTICO PARA BAÑERAS EMMA SIN HIDROMASAJE** 69,3

**CONJUNTO BASTIDOR AUTOPORTANTE**  
41222 **180x80 cm** 188,0

Nota: La bañera con hidromasaje lleva incorporados bastidor y desagüe automático.

## Sensitive Emma 180

bañera hidromasaje agua + aire



€/u

### SENSITIVE TOUCH

Pulsador electrónico, regulador de intensidad masaje agua y sonda de nivel

64138 **180x80 cm**   3.000,0

galaVIP

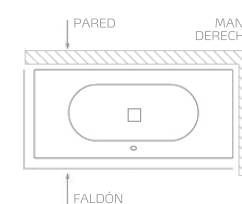
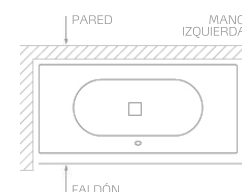

### + FALDONES

€/u

67451 **FALDÓN "L" IZQ** 540,0  
**180x80 cm**

67452 **FALDÓN "L" DCHA** 540,0  
**180x80 cm**

### + REPUESTOS Y ACCESORIOS

€/u

41714 **DESAGÜE AUTOMÁTICO PARA BAÑERAS EMMA SIN HIDROMASAJE** 69,3

**CONJUNTO BASTIDOR AUTOPORTANTE**  
41222 **180x80 cm** 188,0

Nota: La bañera con hidromasaje lleva incorporados bastidor y desagüe automático.



acrílicas rectangulares

**M i t t a**





REPOSACABEZAS



REGULADOR INTENSIDAD  
EMOTIVE TOUCH



MANDO SENSITIVE SMART

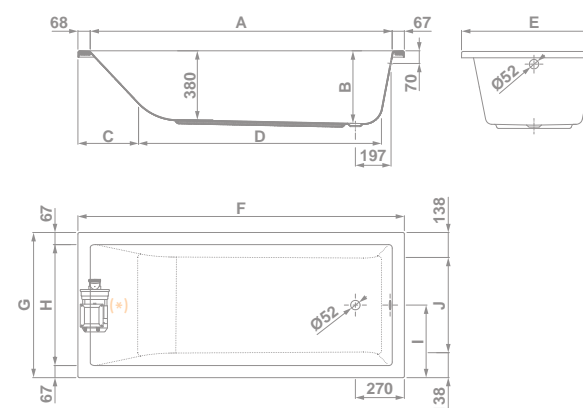
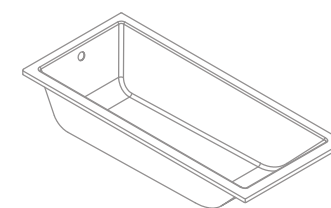

	A	B	C	D	E	F	G	H	I	J
140x70 cm	126,5	40	33,4	94	70	140	70	56,6	35	42,4
150x70 cm	136,6	40	33,4	104	70	150	70	56,6	35	42,4
160x70 cm	146,5	40	33,4	114	70	160	70	56,6	35	42,4
160x75 cm	146,5	40	33,4	114	75	160	75	61,6	37,5	47,5
160x80 cm	146,5	39,5	33,4	114	80	160	80	66,6	40	52,4
170x70 cm	156,5	40	33,2	124,2	70	170	70	56,6	37,5	47,4
170x75 cm	156,5	40	33,2	124,2	75	170	75	61,6	37,5	47,4
170x80 cm	156,5	40	33,4	124	80	170	80	66,6	40	52,5
180x80 cm	166,5	40	33,4	133,9	80	180	80	66,6	40	52,5

### CARACTERÍSTICAS TÉCNICAS

- Posibilidad de instalación con murete o con bastidor autoportante y faldón frontal y/o lateral.
- Altura cubeta: 40 cm
- Altura bañera con bastidor: 52,5 cm
- Desagüe de 52 mm
- Reposacabezas (opcional).

(\*) Sólo disponible en sistemas de hidromasaje

# Mitta

acrílica rectangular



€/u

## SIMPLE MITTA

Sin bastidor y sin desagüe

62831	<b>140x70 cm</b>			235,0
62931	<b>150x70 cm</b>			245,0
62701	<b>160x70 cm</b>			270,0
62601	<b>170x70 cm</b>			280,0
62501	<b>160x75 cm</b>			270,0
62402	<b>170x75 cm</b>			295,0
62561	<b>160x80 cm</b>			325,0
62461	<b>170x80 cm</b>			345,0
62661	<b>180x80 cm</b>			375,0



## FALDONES Y BASTIDORES

	CONJUNTO BASTIDOR*		€/u	FALDÓN FRONTAL**		€/u	FALDÓN LATERAL		€/u
<b>140x70 cm</b>	41560	de 70 cm	60,8	67426	de 140x50 cm	216,0	67432	de 70x50 cm	160,0
<b>150x70 cm</b>	41560	de 70 cm	60,8	67427	de 150x50 cm	219,0	67432	de 70x50 cm	160,0
<b>160x70 cm</b>	41560	de 70 cm	60,8	67429	de 160x50 cm	222,0	67432	de 70x50 cm	160,0
<b>170x70 cm</b>	41560	de 70 cm	60,8	67428	de 170x50 cm	226,0	67432	de 70x50 cm	160,0
<b>160x75 cm</b>	41561	de 75 cm	60,8	67429	de 160x50 cm	222,0	67431	de 75x50 cm	165,0
<b>170x75 cm</b>	41561	de 75 cm	60,8	67428	de 170x50 cm	226,0	67431	de 75x50 cm	165,0
<b>160x80 cm</b>	41563	de 80 cm	65,4	67429	de 160x50 cm	222,0	67430	de 80x50 cm	175,0
<b>170x80 cm</b>	41563	de 80 cm	65,4	67428	de 170x50 cm	226,0	67430	de 80x50 cm	175,0
<b>180x80 cm</b>	41563	de 80 cm	65,4	67436	de 180x50 cm	230,0	67430	de 80x50 cm	175,0

\* Para que la bañera sea autoportante es necesario el bastidor

\*\* Es necesario el bastidor para instalar el faldón



## REPUESTOS Y ACCESORIOS

€/u

68005	<b>DESAGÜE AUTOMÁTICO CROMADO</b>	60,5
68001	<b>PIES REGULABLES BAÑERAS MITTA</b>	33,7

**Nota:** Acabados cromados. La bañera Mitta sólo se suministra en color blanco. GALA recomienda la instalación de la bañera de hidromasaje con faldón, para facilitar el acceso a los componentes del hidromasaje en caso de necesidad. La bañera con hidromasaje lleva incorporados bastidor y desagüe automático.

# Emotive Essential Mitta

bañera hidromasaje agua



		€/u
<b>EMOTIVE ESSENTIAL</b>		
Pulsador neumático y regulador de intensidad		
62833 gala/IP	<b>140x70 cm</b> 45 1	1.185,0
62933 gala/IP	<b>150x70 cm</b> 46 1	1.185,0
62711 gala/IP	<b>160x70 cm</b> 47 1	1.185,0
62611 gala/IP	<b>170x70 cm</b> 48 1	1.185,0

**+ FALDONES**

		FALDÓN FRONTAL		FALDÓN LATERAL		€/u
<b>140x70 cm</b>	67426	<b>de 140x50 cm</b>	216,0	67432	<b>de 70x50 cm</b>	160,0
<b>150x70 cm</b>	67427	<b>de 150x50 cm</b>	219,0	67432	<b>de 70x50 cm</b>	160,0
<b>160x70 cm</b>	67429	<b>de 160x50 cm</b>	222,0	67432	<b>de 70x50 cm</b>	160,0
<b>170x70 cm</b>	67428	<b>de 170x50 cm</b>	226,0	67432	<b>de 70x50 cm</b>	160,0



**+ REPUESTOS Y ACCESORIOS**

68005	<b>DESAGÜE AUTOMÁTICO CROMADO</b>	60,5
68001	<b>PIES REGULABLES BAÑERAS MITTA</b>	33,7

**Nota:** Acabados cromados. La bañera Mitta sólo se suministra en color blanco. GALA recomienda la instalación de la bañera de hidromasaje con faldón, para facilitar el acceso a los componentes del hidromasaje en caso de necesidad. La bañera con hidromasaje lleva incorporados bastidor y desagüe automático.

# Emotive Touch Mitta

bañera hidromasaje agua



€/u

**EMOTIVE TOUCH**

Pulsador electrónico, regulador de intensidad y sonda de nivel

62834 gala/IP	<b>140x70 cm</b>		1.520,0
63934 gala/IP	<b>150x70 cm</b>		1.520,0
62712 gala/IP	<b>160x70 cm</b>		1.520,0
62612 gala/IP	<b>170x70 cm</b>		1.520,0
62513 gala/IP	<b>160x75 cm</b>		1.520,0
62412 gala/IP	<b>170x75 cm</b>		1.575,0
62564 gala/IP	<b>160x80 cm</b>		1.555,0
62485 gala/IP	<b>170x80 cm</b>		1.575,0
62675 gala/IP	<b>180x80 cm</b>		1.690,0

€/u

**EMOTIVE TOUCH DORSAL**

Pulsador electrónico, regulador de intensidad, sonda de nivel, jets dorsales y reposacabezas

62713 gala/IP	<b>160x70 cm</b>		1.850,0
62613 gala/IP	<b>170x70 cm</b>		1.895,0
62514 gala/IP	<b>160x75 cm</b>		1.855,0
62413 gala/IP	<b>170x75 cm</b>		1.900,0
62565 gala/IP	<b>160x80 cm</b>		1.905,0
62486 gala/IP	<b>170x80 cm</b>		1.920,0
62676 gala/IP	<b>180x80 cm</b>		1.990,0

**+ FALDONES**

€/u

FALDÓN FRONTAL		FALDÓN LATERAL		
<b>140x70 cm</b>	67426 de <b>140x50 cm</b>	216,0	67432 de <b>70x50 cm</b>	160,0
<b>150x70 cm</b>	67427 de <b>150x50 cm</b>	219,0	67432 de <b>70x50 cm</b>	160,0
<b>160x70 cm</b>	67429 de <b>160x50 cm</b>	222,0	67432 de <b>70x50 cm</b>	160,0
<b>170x70 cm</b>	67428 de <b>170x50 cm</b>	226,0	67432 de <b>70x50 cm</b>	160,0
<b>160x75 cm</b>	67429 de <b>160x50 cm</b>	222,0	67431 de <b>75x50 cm</b>	165,0
<b>170x75 cm</b>	67428 de <b>170x50 cm</b>	226,0	67431 de <b>75x50 cm</b>	165,0
<b>160x80 cm</b>	67429 de <b>160x50 cm</b>	222,0	67430 de <b>80x50 cm</b>	175,0
<b>170x80 cm</b>	67428 de <b>170x50 cm</b>	226,0	67430 de <b>80x50 cm</b>	175,0
<b>180x80 cm</b>	67436 de <b>180x50 cm</b>	230,0	67430 de <b>80x50 cm</b>	175,0



**+ REPUESTOS Y ACCESORIOS**

€/u

68005	<b>DESAGÜE AUTOMÁTICO CROMADO</b>	60,5
68001	<b>PIES REGULABLES BAÑERAS MITTA</b>	33,7

**Nota:** Acabados cromados. La bañera Mitta sólo se suministra en color blanco. GALA recomienda la instalación de la bañera de hidromasaje con faldón, para facilitar el acceso a los componentes del hidromasaje en caso de necesidad. La bañera con hidromasaje lleva incorporados bastidor y desagüe automático.

# Sensitive Mitta

bañera hidromasaje agua + aire



€/u

**SENSITIVE TOUCH**

Pulsador electrónico, regulador de intensidad masaje agua y sonda de nivel

62714 gala/IP	<b>160x70 cm</b>	 	2.165,0
62614 gala/IP	<b>170x70 cm</b>	 	2.165,0
62515 gala/IP	<b>160x75 cm</b>	 	2.175,0
62414 gala/IP	<b>170x75 cm</b>	 	2.175,0
62566 gala/IP	<b>160x80 cm</b>	 	2.240,0
62487 gala/IP	<b>170x80 cm</b>	 	2.255,0
62677 gala/IP	<b>180x80 cm</b>	 	2.325,0

**+ FALDONES**

€/u

		FALDÓN FRONTAL		FALDÓN LATERAL	
<b>160x70 cm</b>	67429	<b>de 160x50 cm</b>	222,0	67432	<b>de 70x50 cm</b> 160,0
<b>170x70 cm</b>	67428	<b>de 170x50 cm</b>	226,0	67432	<b>de 70x50 cm</b> 160,0
<b>160x75 cm</b>	67429	<b>de 160x50 cm</b>	222,0	67431	<b>de 75x50 cm</b> 165,0
<b>170x75 cm</b>	67428	<b>de 170x50 cm</b>	226,0	67431	<b>de 75x50 cm</b> 165,0
<b>160x80 cm</b>	67429	<b>de 160x50 cm</b>	222,0	67430	<b>de 80x50 cm</b> 175,0
<b>170x80 cm</b>	67428	<b>de 170x50 cm</b>	226,0	67430	<b>de 80x50 cm</b> 175,0
<b>180x80 cm</b>	67436	<b>de 180x50 cm</b>	230,0	67430	<b>de 80x50 cm</b> 175,0



**+ REPUESTOS Y ACCESORIOS**

€/u

68005	<b>DESAGÜE AUTOMÁTICO CROMADO</b>	60,5
68001	<b>PIES REGULABLES BAÑERAS MITTA</b>	33,7

**Nota:** Acabados cromados. La bañera Mitta sólo se suministra en color blanco. GALA recomienda la instalación de la bañera de hidromasaje con faldón, para facilitar el acceso a los componentes del hidromasaje en caso de necesidad. La bañera con hidromasaje lleva incorporados bastidor y desagüe automático.

acrílicas rectangulares

# **N i l a**



## CARACTERÍSTICAS TÉCNICAS

- Posibilidad de instalación con murete o con bastidor autoportante y faldón
- Altura cubeta: 40 cm
- Altura bañera con bastidor: 56,5 cm
- Desagüe de 52 mm

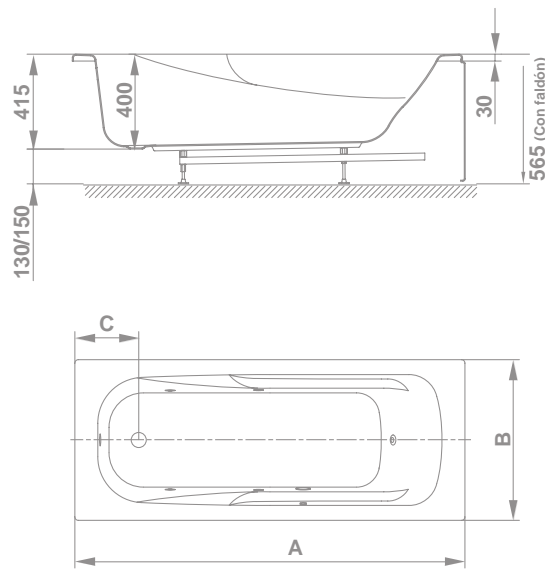

	A	B	C
<b>140x70 cm</b>	140	70	25,8
<b>150x70 cm</b>	150	70	25,8
<b>160x70 cm</b>	160	70	27,8
<b>170x70 cm</b>	170	70	27,8
<b>160x75 cm</b>	160	75	27,8
<b>170x75 cm</b>	170	75	27,8

# Nilá

acrílica rectangular



		€/u	
<b>SIMPLE NILA</b>			
Sin pie, sin bastidor y sin desagüe.			
60411	<b>140x70 cm</b>		210,0
60311	<b>150x70 cm</b>		215,0
60211	<b>160x70 cm</b>		235,0
60111	<b>170x70 cm</b>		245,0
60611	<b>160x75 cm</b>		240,0
60511	<b>170x75 cm</b>		250,0



## FALDONES Y BASTIDORES

	CONJUNTO BASTIDOR*	€/u	FALDÓN FRONTAL**	€/u	FALDÓN LATERAL	€/u
<b>140x70 cm</b>	41560 de 70 cm	60,8	69865 de 140x50 cm	190,0	69866 de 70x50 cm	107,0
<b>150x70 cm</b>	41560 de 70 cm	60,8	69864 de 150x50 cm	193,5	69866 de 70x50 cm	107,0
<b>160x70 cm</b>	41560 de 70 cm	60,8	69863 de 160x50 cm	196,7	69866 de 70x50 cm	107,0
<b>170x70 cm</b>	41560 de 70 cm	60,8	69862 de 170x50 cm	203,0	69866 de 70x50 cm	107,0
<b>160x75 cm</b>	41561 de 75 cm	60,8	69863 de 160x50 cm	196,7	69867 de 75x50 cm	107,0
<b>170x75 cm</b>	41561 de 75 cm	60,8	69862 de 170x50 cm	203,0	69867 de 75x50 cm	107,0

\* Para que la bañera sea autoportante es necesario el bastidor

\*\* Es necesario el bastidor para instalar el faldón



## REPUESTOS Y ACCESORIOS

	€/u
68005 <b>DESAGÜE AUTOMÁTICO CROMADO</b>	60,5
68001 <b>PIES REGULABLES BAÑERAS NILA</b>	33,7

**Nota:** Acabados cromados. La bañera Nilá sólo se suministra en color blanco. GALA recomienda la instalación de la bañera de hidromasaje con faldón, para facilitar el acceso a los componentes del hidromasaje en caso de necesidad. La bañera Nilá con hidromasaje lleva incorporado bastidor.



acrílicas angulares

# Flex Center 135





## Flex Center 135

acrílica angular



60 1 € / u

65510 **SIN FALDÓN** 1.335,0  
Con bastidor, desagüe y reposacabezas

60 1 € / u

65551 **CON FALDÓN** 2.020,0  
Con bastidor, desagüe y reposacabezas

**+ FALDONES** € / u  
6741602 **FALDÓN NEGRO FLEX CENTER ANGULAR** 835,0

### CARACTERÍSTICAS TÉCNICAS

- Posibilidad de instalación con murete o con bastidor autoportante y faldón en L negro.
- Grandes dimensiones: 135x135 cm
- Altura cubeta: 42 cm  
Altura bañera con faldón: 60 cm
- Desagüe automático de 52 mm y rebosadero ocultos.
- Reposacabezas integrados.
- Sistemas de hidromasaje Flex Center: máxima calidad y confort.

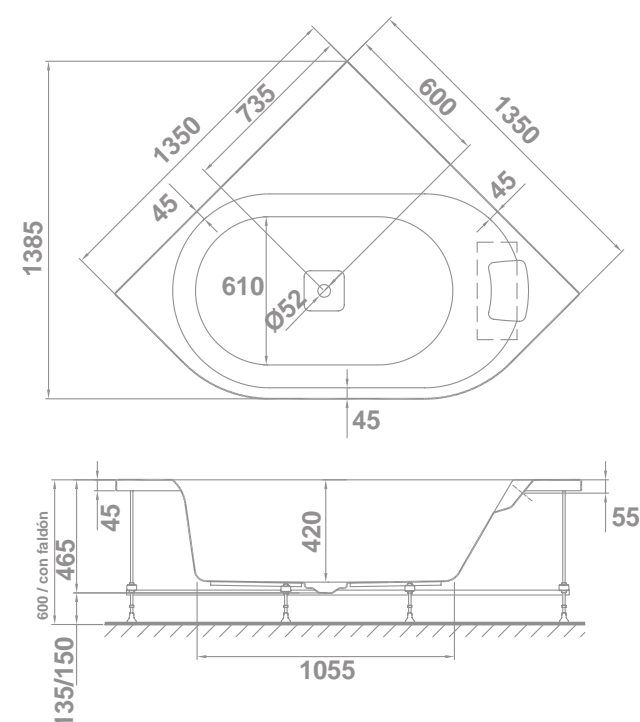

**Nota:** Acabados cromados. La bañera Flex Center sólo se suministra en color blanco. GALA recomienda la instalación de la bañera de hidromasaje con faldón, para facilitar el acceso a los componentes del hidromasaje en caso de necesidad. La bañera con hidromasaje lleva incorporados bastidor y desagüe automático.

## Emotive Flex Center 135

bañera hidromasaje agua



 		€/u
65548	<b>SIN FALDÓN</b> Pulsador electrónico, regulador de intensidad, sonda de nivel y jets lumbares/plantares	3.320,0
65552	<b>CON FALDÓN NEGRO</b> Pulsador electrónico, regulador de intensidad, sonda de nivel y jets lumbares/plantares	4.030,0

 <b>FALDONES</b>		€/u
6741602	<b>FALDÓN NEGRO FLEX CENTER ANGULAR</b>	835,0

**Nota:** Acabados cromados. La bañera Flex Center sólo se suministra en color blanco. GALA recomienda la instalación de la bañera de hidromasaje con faldón, para facilitar el acceso a los componentes del hidromasaje en caso de necesidad. La bañera con hidromasaje lleva incorporados bastidor y desagüe automático.

## Sensitive Flex Center 135

bañera hidromasaje agua + aire



 		€/u
65549	<b>SIN FALDÓN</b> Pulsador electrónico, regulador de intensidad masajes agua+aire, sonda de nivel y jets lumbares/plantares	4.180,0
65553	<b>CON FALDÓN NEGRO</b> Pulsador electrónico, regulador de intensidad masajes agua+aire, sonda de nivel y jets lumbares/plantares	4.870,0

 <b>FALDONES</b>		€/u
6741602	<b>FALDÓN NEGRO FLEX CENTER ANGULAR</b>	835,0

**Nota:** Acabados cromados. La bañera Flex Center sólo se suministra en color blanco. GALA recomienda la instalación de la bañera de hidromasaje con faldón, para facilitar el acceso a los componentes del hidromasaje en caso de necesidad. La bañera con hidromasaje lleva incorporados bastidor y desagüe automático.



acrílicas angulares  
**Trevo**



# Trevo



acrílica angular

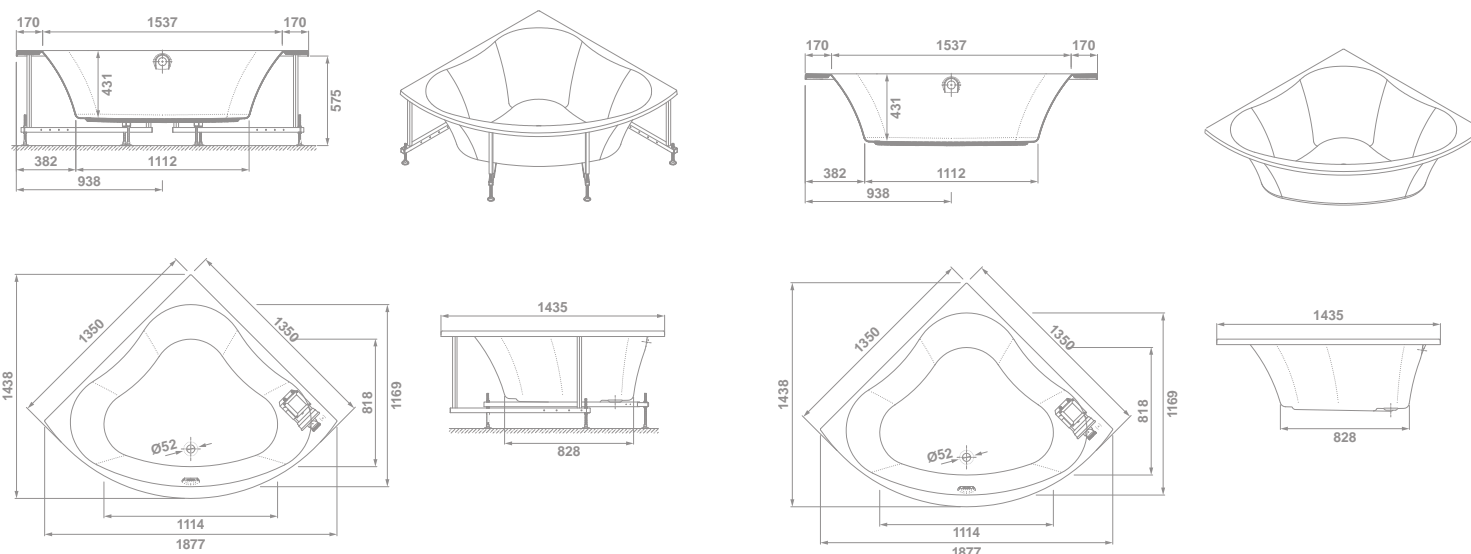

## CARACTERÍSTICAS TÉCNICAS

- Posibilidad de instalación con murete o con bastidor autoportante y faldón.
- Altura cubeta: 43,1 cm
- Altura bañera con bastidor: 57,5 cm
- Medidas: 135x135
- Desagüe de 52 mm .
- Reposacabezas (opcional).



	€/u
61981 <b>SIMPLE TREVO</b> Sin pies y sin desagüe	490,0
 	
61982 <b>SIMPLE TREVO</b> Con bastidor y sin desagüe	785,0
 	

+ FALDONES		€/u
67490 <b>FALDÓN TREVO ANGULAR</b> de 135x135x56 cm*		290,0

\* Para instalación con faldón es necesario bastidor

+ REPUESTOS Y ACCESORIOS		€/u
68005 <b>DESAGÜE AUTOMÁTICO CROMADO</b>		60,5

## Emotive Trevo

bañera hidromasaje agua



€/u

61983 **EMOTIVE TOUCH** 1.625,0  
galaVIP Pulsador electrónico, regulador de intensidad y sonda de nivel



€/u

61984 **EMOTIVE TOUCH DORSAL** 2.165,0  
galaVIP Pulsador electrónico, regulador de intensidad, sonda de nivel, jets dorsales y reposacabezas



### FALDONES

€/u

67490 **FALDÓN TREVO ANGULAR** 290,0  
 de 135x135x56 cm\*

\* Para instalación con faldón es necesario bastidor



### REPUESTOS Y ACCESORIOS

€/u

68005 **DESAGÜE AUTOMÁTICO CROMADO** 60,5

**Nota:** La bañera con hidromasaje lleva incorporados bastidor y desagüe automático.

## Sensitive Trevo

bañera hidromasaje agua + aire



€/u

61985 **SENSITIVE TOUCH** 2.680,0  
galaVIP Pulsador electrónico, regulador intensidad masajes agua y sonda de nivel.



### FALDONES

€/u

67490 **FALDÓN TREVO ANGULAR** 290,0  
 de 135x135x56 cm\*

\* Para instalación con faldón es necesario bastidor



### REPUESTOS Y ACCESORIOS

€/u

68005 **DESAGÜE AUTOMÁTICO CROMADO** 60,5

**Nota:** La bañera con hidromasaje lleva incorporados bastidor y desagüe automático.



acrílicas circulares  
**Omega**

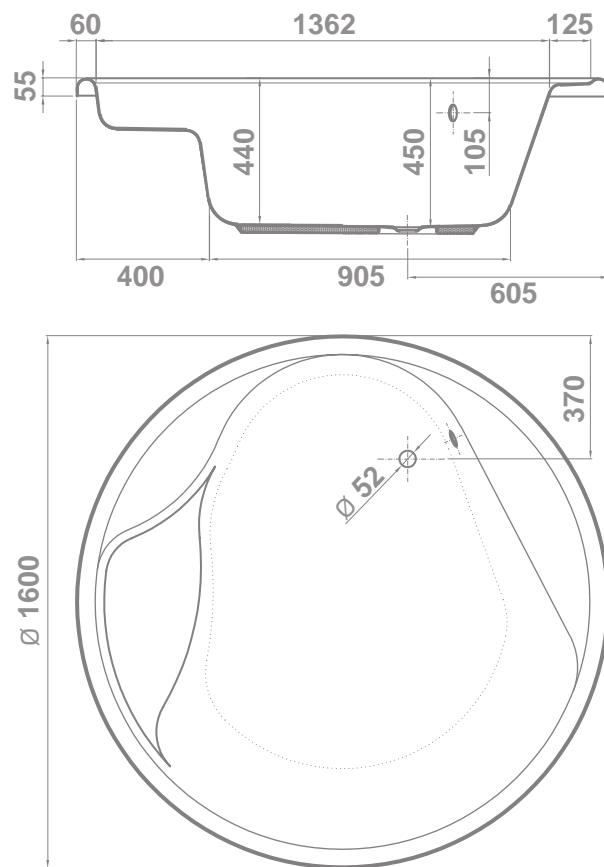

## Omega

acrílica circular



## Emotive Omega

bañera hidromasaje agua



## Sensitive Omega

bañera hidromasaje agua + aire



### CARACTERÍSTICAS TÉCNICAS

- Diámetro de 160 cm
- Altura cubeta: 45 cm
- Altura bañera con bastidor: 60 cm
- Desagüe de 52 mm

	€/u
68740 <b>SIMPLE OMEGA</b> Sin pies y sin desagüe	830,0
68700 <b>SIMPLE OMEGA</b> Con bastidor y sin desagüe	985,0
<b>+ REPUESTOS Y ACCESORIOS</b>	€/u
68005 <b>DESAGÜE AUTOMÁTICO CROMADO</b>	60,5

	€/u
68781 <b>EMOTIVE TOUCH</b> Pulsador electrónico, regulador de intensidad y sonda de nivel	2.155,0
<b>+ REPUESTOS Y ACCESORIOS</b>	€/u
68005 <b>DESAGÜE AUTOMÁTICO CROMADO</b>	60,5

	€/u
68783 <b>SENSITIVE TOUCH</b> Pulsador electrónico, regulador de intensidad masaje agua y sonda de nivel	3.600,0
<b>+ REPUESTOS Y ACCESORIOS</b>	€/u
68005 <b>DESAGÜE AUTOMÁTICO CROMADO</b>	60,5

Nota: Acabados cromados. La bañera Omega sólo se suministra en color blanco.

Nota: Acabados cromados. La bañera Omega sólo se suministra en color blanco. La bañera con hidromasaje lleva incorporados bastidor y desagüe automático.

bañeras de acero

# Ópera







**ÓPERA EXENTA CON FALDÓN**  
180 x 80 cm

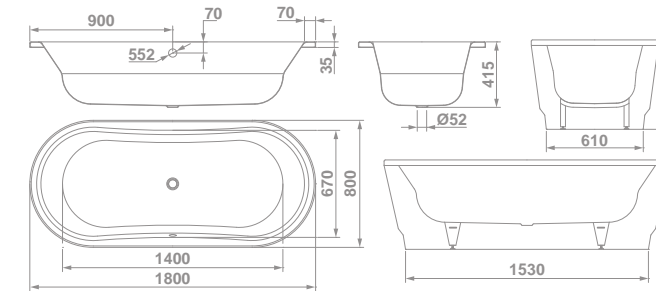

**ÓPERA PARA ENCASTRAR**  
180 x 80 cm

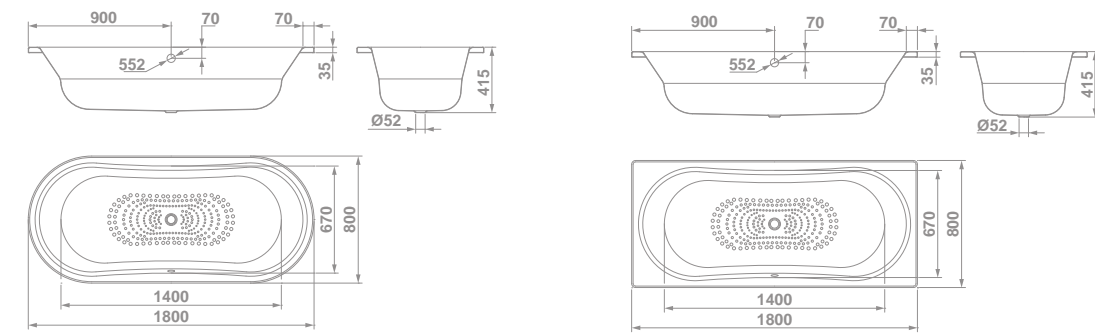

**CARACTERÍSTICAS TÉCNICAS**

- Acero de 3,5 mm de espesor.
- 30 años de garantía.
- Instalación: exenta con faldón, para encastrar rectangular y para encastrar oval.
- Altura cubeta: 41,5 cm
- Altura bañera exenta: 55 cm
- Desagüe de 52 mm
- Antideslizante de aportación.
- Placas insonorizantes.



# Ópera exenta

bañeras de acero



	€/u
63031 <b>BAÑERA ÓPERA EXENTA</b> Con faldón de 180x180 cm Insonorizada. Pies incluidos. Válvula incluida.	87,9 1
01 <b>BLANCO</b>	4.430,0
02 <b>NEGRO</b>	5.150,0

+ REPUESTOS Y ACCESORIOS		€/u
68023 <b>JUEGOS DE PIES ADHESIVOS</b>		42,0
68005 <b>DESAGÜE AUTOMÁTICO CROMADO</b>		60,5



# Ópera para encastrar

bañeras de acero



			€/u
63034	<b>ÓPERA PARA ENCASTRAR</b>	1.080,0	
	De 180x80 cm. Insonorizada. Antideslizante de aportación.		

**+ REPUESTOS Y ACCESORIOS** €/u

68023	<b>JUEGOS DE PIES ADHESIVOS</b>	42,0
68005	<b>DESAGÜE AUTOMÁTICO CROMADO</b>	60,5

# Ópera rectangular

bañeras de acero



			€/u
63035	<b>ÓPERA RECTANGULAR</b>	705,0	
	De 180x80 cm. Insonorizada. Antideslizante de aportación.		

**+ REPUESTOS Y ACCESORIOS** €/u

68023	<b>JUEGOS DE PIES ADHESIVOS</b>	42,0
68005	<b>DESAGÜE AUTOMÁTICO CROMADO</b>	60,5

bañeras de acero

# V a n e s a





# Vanesa

bañeras de acero



€/u

## VANESA

Asas cromadas. Insonorizada. Antideslizante de aportación.

67350	<b>150x75x42 cm</b> 27,6 10	385,0
67360	<b>160x75x42 cm</b> 29,8 10	400,0
67370	<b>170x75x42 cm</b> 30,9 10	415,0



## REPUESTOS Y ACCESORIOS

€/u

68023	<b>JUEGOS DE PIES ADHESIVOS</b>	42,0
68015	<b>JUEGOS DE ASAS CROMADAS</b>	70,0
68005	<b>DESAGÜE AUTOMÁTICO CROMADO</b>	60,5

## CARACTERÍSTICAS TÉCNICAS

- Acero de 2,5 mm de espesor.
- 5 años de garantía.
- Asas cromadas incluidas.
- Altura bañera: 42 cm
- Desagüe de 52 mm
- Antideslizante de aportación.
- Placas insonorizantes.

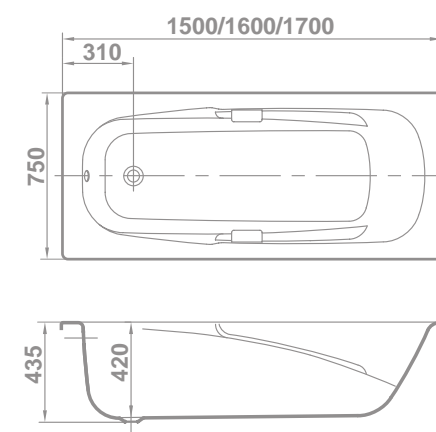

Nota: Acabados cromados.

bañeras de acero  
**F e d r a**





# Fedra

bañeras de acero



	€/u
64000 <b>140x70x40 cm</b>  	210,0
65000 <b>150x70x40 cm</b>  	220,0
66000 <b>160x70x40 cm</b>  	230,0
67000 <b>170x70x40 cm</b>  	240,0

## CARACTERÍSTICAS TÉCNICAS

- Acero de 2,5 mm de espesor.
- 5 años de garantía.
- Altura bañera: 40 cm
- Desagüe de 52 mm

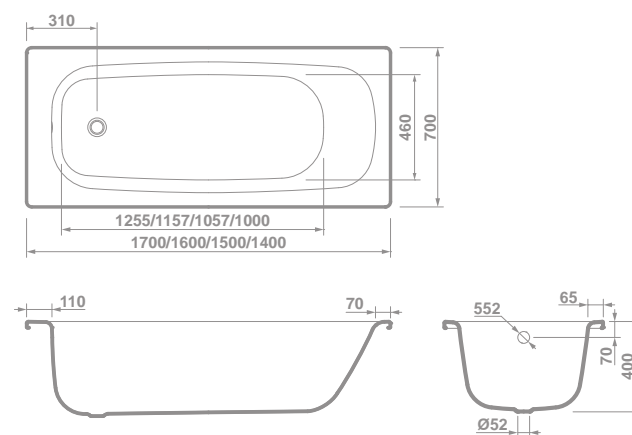

## + REPUESTOS Y ACCESORIOS

	€/u
68023 <b>JUEGOS DE PIES ADHESIVOS</b>	42,0
68005 <b>DESAGÜE AUTOMÁTICO CROMADO</b>	60,5



bañeras de acero  
**G a l a**





# Gala

bañeras de acero



€/u

## GALA SIN FONDO ANTIDESLIZANTE DE APORTACIÓN

Desagüe de 52 mm (no incluido).

62002 **105x70x37,5 cm** 187,5

€/u

## GALA CON FONDO ANTIDESLIZANTE DE APORTACIÓN

Desagüe de 52 mm (no incluido).

63000 **120x70x38,5 cm** 200,0

63005 **130x70x38,5 cm** 202,5

63010 **140x70x38,5 cm** 205,0

63015 **150x70x38,5 cm** 207,5

63020 **160x70x38,5 cm** 210,0

63025 **170x70x38,5 cm** 215,0

	A	B	C	D	E	F	G	H	I	J	Litros
<b>105 cm</b>	105	72,5	70	57	7	6,5	28,5	2,8	7	37,5	120
<b>120 cm</b>	120	80,5	70	57	7	6,5	28,5	2,8	7	38,5	140
<b>130 cm</b>	130	90,5	70	57	7	6,5	28,5	2,8	7	38,5	150
<b>140 cm</b>	140	100,5	70	57	7	6,5	28,5	2,8	7	38,5	160
<b>150 cm</b>	150	110,5	70	57	7	6,5	28,5	2,8	7	38,5	170
<b>160 cm</b>	160	120,5	70	57	7	6,5	28,5	2,8	7	38,5	180
<b>170 cm</b>	170	130,5	70	57	7	6,5	28,5	2,8	7	38,5	190

### CARACTERÍSTICAS TÉCNICAS

- Acero de 2,5 mm de espesor.
- 5 años de garantía.
- Altura bañera: 38,5 cm
- Desagüe de 52 mm
- Antideslizante de aportación.

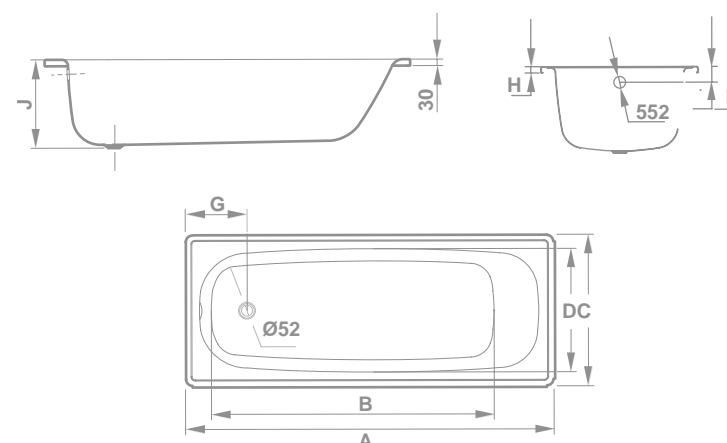

### + REPUESTOS Y ACCESORIOS

68023	<b>JUEGOS DE PIES ADHESIVOS</b>	42,0
68005	<b>DESAGÜE AUTOMÁTICO CROMADO</b>	60,5

# tarifa 80

# Condiciones

## generales de venta

Todas las relaciones comerciales entre Cerámicas Gala, S.A. y sus clientes se regirán por las siguientes condiciones generales de venta, que se entenderán aceptadas por el comprador por el solo hecho de cursar un pedido. Todas las medidas y colores descritos son orientativos. Por razones técnicas o comerciales, Cerámicas Gala, S.A. se reserva el derecho de realizar en cualquier momento cambios en los precios, materiales y especificaciones de los modelos descritos previa notificación.

### CATÁLOGOS, OFERTAS Y PEDIDOS

Las indicaciones de nuestros catálogos se dan solamente a título orientativo. Las ofertas están siempre, y a todos los efectos, condicionadas a nuestra posterior aceptación, por escrito, del correspondiente pedido. Cualquier condición consignada por el comprador en el pedido que no se ajuste a las condiciones generales de venta o –en su caso– a las especiales de cada producto, se considerará nula, salvo nuestra conformidad, que deberá constar expresamente en la aceptación escrita del pedido.

### GALANET

Les recordamos que cualquier pedido que realicen a través de nuestro portal de venta GALANET se tramita con mayor agilidad puesto que dicho pedido entra directamente en sistema.

### ENVÍOS PORTES EN FACTURA

**Envíos de piezas con portes cargados en facturas**  
Con el ánimo de facilitar el envío de material de forma ágil en pedidos de pocas unidades o para pedidos que tengan que ir a portes debidos por no ser artículos del sistema VIP, les ofrecemos la opción de cargar los portes en factura. Entrega de pedido en un plazo de 10 días desde que se realiza acuse de recibo del pedido indicado como portes en factura. Los productos detallados a continuación siempre tienen un coste fijo en los envíos por la agencia a cualquier punto de la península, con las siguientes consideraciones:

#### Para artículos de sanitario:

Hasta 150 Euros .....  
25 euros de portes  
De 151 a 600 Euros .....  
60 euros de portes  
De 601 a 1.500 Euros .....

75 euros de portes  
Más de 1.500 Euros .....  
Sin cargo de portes  
**Para envíos exclusivos de bañeras acrílicas sin hidromasaje:**  
Bañera rectangular .....  
40 euros de portes  
Bañera angular .....  
55 euros de portes

### PARA ENVÍO EXCLUSIVO DE PEDIDOS DE GRIFERÍA Y ACCESORIOS

**Sistema de expedición de grifería y accesorios**  
Los envíos de grifería y accesorios que superen los 180 euros se enviarán a portes pagados por agencia de transporte a la dirección del distribuidor. Los envíos de accesorios con un importe menor a 180 euros se enviarán también mediante agencia de transporte cargando 10 euros de portes en factura en concepto de gastos de manipulación y transporte.

El pedido mínimo de material será de 6 uds para los productos de grifería de lavabos en las series ARLAN, MENA y CLUNIA.

### ANULACIÓN DE PEDIDOS

Los pedidos aceptados no podrán ser anulados en los casos siguientes:

- Cuando se haya efectuado la expedición del producto.
- Cuando, tratándose de materiales de fabricación especial, ésta se hubiera comenzado.

Nos reservamos el derecho de anular los pedidos pendientes de entrega cuando el comprador hubiere incumplido, total o parcialmente, anteriores contratos.

### PRECIOS

Los precios que figuran en esta tarifa son en euros y sobre camión almacén del cliente distribuidor. Nuestros precios de venta podrán ser variados por simple aviso al comprador. Los nuevos precios serán aplicados a todos los pedidos pendientes de entrega en la fecha de la modificación. Si el comprador no aceptase el nuevo precio podrá anular el pedido, notificándolo, por escrito, dentro de los ocho días siguientes a la fecha de aviso. Pasado este plazo se entenderá que acepta plenamente las nuevas condiciones.

Se aplicará en factura, sobre los precios netos resultantes, el impuesto actualmente en vigor I.V.A. y cualquier otro gravamen que dictamine la Ley.

### PLAZOS DE ENTREGA

Los plazos de entrega que consten en nuestras aceptaciones de pedido serán meramente orientativos. Los retrasos en la entrega originados por causas de fuerza mayor, o que no nos sean directamente imputables, no serán causa justificada para la anulación por el comprador del pedido involuntariamente demorado, ni de reclamación alguna de daños y perjuicios.

### FORMA DE ENTREGA

Las mercancías se entienden entregadas sobre camión almacén del cliente distribuidor. Nuestros productos viajan por cuenta y riesgo del comprador, aun cuando lo hagan a portes pagados. A la recepción de la mercancía, el destinatario debe comprobarla y hacer las reclamaciones oportunas al transportista antes de firmar el albarán de entrega contando con un plazo de 48 horas para notificar a Cerámicas Gala, S.A. cualquier abono de pieza por rotura. Transcurrido ese plazo la agencia de transporte no admitirá abono alguno. Los pedidos que nos cursen, salvo que la naturaleza del producto lo impida, podrán cumplimentarse en entregas parciales, informando previamente al cliente. Salvo instrucciones concretas del comprador, los envíos de mercancías se efectuarán por camión programado por fábrica. Si el cliente no puede esperar el envío del camión programado por fábrica, el material que nos solicite se enviará a portes debidos, salvo que en las condiciones de venta pactadas con Cerámicas Gala, S.A. se indique lo contrario.

### BONIFICACIONES

Cualquier descuento, rappel, bonificación o abono que sobre los precios de tarifa se conceda estará condicionado al buen fin de las operaciones de las que dichos beneficios traigan causa o que hubieran sido realizadas durante el período que, en su caso, corresponda; consecuentemente, se perderá el derecho a su percepción si se incurre en impago o morosidad en la operación o durante el período computado

### EMBALAJES

Nuestras mercancías se expedirán embaladas en la forma más idónea para su transporte: palet, caja de cartón, etc., atendándose, en lo razonadamente posible, las instrucciones del comprador sobre otras clases o formas de embalaje, siendo su coste a cargo del comprador. Salvo aviso en contrario, o que se señale en las tarifas de venta de cada producto, el coste de los embalajes figura incluido en el precio de las mercancías. No se admite la devolución de nuestros embalajes, por ser del tipo no recuperable.

### CONDICIONES DE PAGO

El pago del precio de nuestras mercancías se efectuará directamente a nuestro Departamento Administrativo de Burgos, salvo que se conceda crédito al comprador, en cuyo caso se hará efectivo en el plazo o plazos estipulados expresamente. Para facilitar la efectividad del pago se podrán girar efectos cambiarios a cargo del comprador, sin que ello signifique una modificación, ni de fecha, ni de lugar de pago, determinado anteriormente. Si antes de la cumplimentación de la totalidad o parte de un pedido se produjesen o conociesen hechos o circunstancias que originen un fundado temor de que el comprador incumplirá su obligación de pago del precio, se podrá suspender la entrega de las mercancías, si el comprador no anticipa su pago o fianza en el plazo convenido.

### GARANTÍA

Los productos de Gala están garantizados ante cualquier defecto de fabricación, desde la fecha de adquisición del producto, siempre y cuando la instalación haya sido efectuada de acuerdo con las instrucciones de instalación facilitadas por Cerámicas Gala, S.A. y, aplicando la normativa en vigor para instalaciones eléctricas y de saneamiento, por personal autorizado. Salvo que se indique otro plazo específico para un producto determinado, los períodos de garantía serán los siguientes:

- Porcelana sanitaria: 5 años.
- Asientos y tapas para bidé: 3 años.
- Sistemas de instalación: 5 años.
- Griferías: durante 5 años.
- Los componentes internos de las griferías termostáticas, las griferías electrónicas, las

griferías temporizadas, las duchas de mano, sets y kits de ducha, así como los complementos de grifería, tienen una garantía de 3 años.

- Muebles de baño: 3 años.
- Accesorios: 5 años.
- Platos surface: 3 años.
- Mamparas: 3 años.
- Bañeras acrílicas y platos acrílicos: 3 años.
- Bañeras de acero: 5 años.
- Bañeras y platos de acero de gran espesor: 30 años.
- Componentes (producto general): 3 años.
- Cabinas y columnas de hidromasaje: 3 años
- Gala-Drain: 3 años.

Las cabinas de Hidromasaje deben ser instaladas por el Servicio de Asistencia Técnica Oficial de Cerámicas Gala, S.A. En caso contrario supone la pérdida de la garantía. Consulte condiciones de instalación en el teléfono 947474100 o en el Email galasat@gala.es.

La garantía no cubre los defectos y daños ocasionados por el uso incorrecto, manipulación indebida o inadecuado almacenamiento después de ser expedido el producto desde nuestra Fábrica, la instalación no realizada de acuerdo con las instrucciones escritas que se suministran, las reparaciones con recambios no originales o por personal no autorizado, la falta de mantenimiento o cualquier otra anomalía que no sea debida a defectos de fabricación. Para el disfrute de esta garantía será necesaria la aceptación del defecto por nuestro Departamento Técnico, debiendo ser enviado el producto a la Fábrica de Burgos. Cerámicas Gala, S.A. no se responsabilizará de ningún daño que se pueda producir por fugas de agua una vez instalados los productos. Cerámicas Gala, S.A. garantiza la reparación o reemplazo gratuito del conjunto o parte del mismo, siempre que la notificación del defecto se produzca dentro del período de garantía, en los términos establecidos por la legislación vigente.

### RECLAMACIONES

Además de la garantía que cubre nuestros productos, atenderemos las reclamaciones justificadas por error o defecto en la cantidad de los mismos siempre que nos sean cursadas dentro de los 10 días siguientes al recibo de la mercancía.

### DEVOLUCIONES

No se admiten sin nuestra previa autorización. No se admitirán devoluciones de material en un plazo superior a 48 horas desde la entrega en destino. De su importe se deducirá un porcentaje no inferior al 10% en concepto de gastos de recepción, prueba e inspección y demérito, salvo que se especifique otro porcentaje en las tarifas de cada producto. Se enviarán, franco portes, a nuestra fábrica de Burgos. Cuando aceptamos una devolución de material, el abono correspondiente se realizará después de la recepción y comprobación del mismo por nuestro control de calidad. Las piezas rechazadas son propiedad del cliente, que dispondrá de 60 días para retirarlas de nuestro almacén.

### JURISDICCIÓN

Los compradores, al igual que esta sociedad Cerámicas Gala, S.L., se someten expresamente a la Jurisdicción de los Tribunales y Juzgados de Burgos, con renuncia a cualquier otro fuero o jurisdicción.

### galá/IP

Los productos galá/IP se envían directamente a los almacenes en un envío con nuestro compromiso es expedir los productos marcados con logotipo galá/IP en el plazo de diez días desde que se realiza el acuse de recibo. Con stock de producto en almacenes, desde el momento del pedido.

### galá/IP

Estos productos son para venta exclusiva en tienda y no tienen ningún tipo de descuento comercial.

### galá/IP

Envíos galá/IP: Todos los pedidos de productos realizados bajo el distintivo indicado que se realicen durante una semana, se agruparán en su totalidad para enviar directamente a los almacenes en único envío semanal.

Los productos indicados en el siguiente listado han pasado a descatalogarse en 2023.

En venta hasta fin de existencias.

## Colecciones

Referencia	Descripción	Serie
5164201	Asiento extraíble	EMMA SQUARE
5166201	Asiento extraíble blanco	EMMA
5130100	Asiento fijo madera maciza nogal	NOSTALGIA
0914001	Inodoro tanque alto BTW 56 x 36 cm.	CORAL
0514001	Inodoro tanque alto BTW 55 x 35,5 cm.	STREET SQUARE
6800200	Válvula de desagüe cromada de 90 mm.	VARIOS

## Lavabos

Referencia	Descripción	Serie
3402001	Lavabo sobre-encimera 60 cm. rectangular	EOS
3404001	Lavabo sobre-encimera 40 cm. cuadrado	EOS
3405001	Lavabo sobre-encimera 40 cm. redondo	EOS
3304002	Lavabo encimera 90 x 40 cm. negro	KLEA
3305002	Lavabo encimera 65 x 35 cm. negro	KLEA
3304027	Lavabo encimera 90 x 40 cm. perla	KLEA
3304043	Lavabo encimera 90 x 40 cm. beige	KLEA
3304096	Lavabo encimera 90 x 40 cm. onix	KLEA
3305027	Lavabo encimera 65 x 35 cm. perla	KLEA
3305043	Lavabo encimera 65 x 35 cm. beige	KLEA
3305096	Lavabo encimera 65 x 35 cm. onix	KLEA
1304002	Lavabo 45 cm. sobre-encimera, sin repisa negro	URBAN
1304021	Lavabo 45 cm. sobre-encimera, sin repisa blanco mate	URBAN
1304027	Lavabo 45 cm. sobre-encimera, sin repisa perla	URBAN
1304043	Lavabo 45 cm. sobre-encimera, sin repisa beige	URBAN
1304096	Lavabo 45 cm. sobre-encimera, sin repisa onix	URBAN
1807001	Lavabo semiempotrar 55 cm. blanco	ELIA
0425001	Lavabo sobre-encimera 63 x 43 cm.	ELIPSE
2705002	Lavabo sobre-encimera 50 x 38 cm. negro	EMMA SQUARE
2705027	Lavabo sobre-encimera 50 x 38 cm. perla	EMMA SQUARE
2705043	Lavabo sobre-encimera 50 x 38 cm. beige	EMMA SQUARE
2705096	Lavabo sobre-encimera 50 x 38 cm. onix	EMMA SQUARE
3003001	Lavabo sobremueble 101 cm.	EMMA
3005001	Lavabo sobremueble 81 cm.	EMMA
1005401	Lavabo de 60 x 46 cm.	SMILE
1005601	Lavabo de 80,5 x 46 cm.	SMILE
1015601	Lavabo 101 cm.	SMILE

1015701	Lavabo 121 cm.	SMILE
1008701	Lavabo mueble 101 x 46 cm. blanco	SMILE
1005701	Lavabo mueble 80 x 46 cm. blanco	SMILE
1008801	Lavabo mueble 121 x 46 cm. blanco	SMILE

## Espejos

Referencia	Descripción	Serie
3842500	Espejo 80 x 60 cm. luz LED	KLEA
3828200	Espejo 80 x 60 x 3 cm. luz LED	ÁGATA

## Piezas especiales

Referencia	Descripción	Serie
2957001	Tanque alto sin tapa blanco	MEDUNA

## Mecanismos encajados

Referencia	Descripción	Serie
7059501	Inodoro tanque BTW de 55 x 35,5 cm.	STREET SQUARE
7188901	Semi-recessed wash-basin 55 x 45,5 cm.	ELIA

## Platos de ducha

Referencia	Descripción	Serie
6383001	110 x 70 cm. 8 cm. de altura con antideslizante	ESFERA
6383101	130 x 70 cm. 8 cm. de altura con antideslizante	ESFERA
6383201	150 x 70 cm. 8 cm. de altura con antideslizante	ESFERA
6383301	170 x 70 cm. 8 cm. de altura con antideslizante	ESFERA
6386101	Plato ducha 80 cm. angular	ESFERA
6386201	Plato ducha 80 x 80 cm.	ESFERA
6386401	Plato ducha 90 cm. angular	ESFERA
6386501	Plato ducha 90 x 90 cm.	ESFERA
6386601	Plato ducha 100 x 70 cm.	ESFERA
6386701	Plato ducha 100 x 100 cm.	ESFERA
6386801	Plato ducha 120 x 70 cm.	ESFERA
6386901	Plato ducha 140 x 70 cm.	ESFERA
6387701	Plato ducha 160 x 70 cm.	ESFERA
6392701	Plato ducha 100 x 70 cm. - 3 Cm. altura con desagüe 90 mm. blanco	SIGMA
6392801	Plato ducha 120 x 80 cm. - 3 cm. altura con desagüe 90 mm. blanco	SIGMA
6392901	Plato ducha 140 x 70 cm. - 3 cm. altura con desagüe 90 mm. blanco	SIGMA
6393501	Plato ducha 100 x 90 cm. - 5 cm. altura con desagüe 90 mm. blanco	VITA
6393601	Plato ducha 120 x 90 cm. - 5 cm. altura con desagüe 90 mm. blanco	VITA
6393701	Plato ducha 140 x 90 cm. - 5 cm. altura con desagüe 90 mm. blanco	VITA
6393801	Plato ducha 160 x 90 cm. - 5 cm. altura con desagüe 90 mm. blanco	VITA
6394501	Plato ducha 80 x 80 cm. - 5 cm. altura con desagüe 90 mm. blanco	VITA
6394601	Plato ducha 80 angular - 5 cm. altura con desagüe 90 mm. blanco	VITA
6394701	Plato ducha 90 x 90 cm. - 5 cm. altura con desagüe 90 mm. blanco	VITA
6394801	Plato ducha 90 angular cm. - 5 cm. altura con desagüe 90 mm. blanco	VITA









# descatalogados

6349602	Plato ducha resina con desagüe 160 x 90 cm. negro	SUITE-N
6349623	Plato ducha resina con desagüe 160 x 90 cm. gris piedra	SUITE-N
6349624	Plato ducha resina con desagüe 160 x 90 cm. topo	SUITE-N
6349625	Plato ducha resina con desagüe 160 x 90 cm. moka	SUITE-N
6349626	Plato ducha resina con desagüe 160 x 90 cm. perla	SUITE-N
6349627	Plato ducha resina con desagüe 160 x 90 cm. gris claro	SUITE-N
6349628	Plato ducha resina con desagüe 160 x 90 cm. hormigón	SUITE-N
6349629	Plato ducha resina con desagüe 160 x 90 cm. gris oliva	SUITE-N
6349643	Plato ducha resina con desagüe 160 x 90 cm. arena	SUITE-N
6349644	Plato ducha resina con desagüe 160 x 90 cm. chocolate	SUITE-N
6349645	Plato ducha resina con desagüe 160 x 90 cm. gris plata	SUITE-N
6349650	Plato ducha resina con desagüe 160 x 90 cm. marfil	SUITE-N
6349682	Plato ducha resina con desagüe 160 x 90 cm. wengué	SUITE-N
6349684	Plato ducha resina con desagüe 160 x 90 cm. antracita	SUITE-N
6349801	Plato ducha resina con desagüe 180 x 90 cm. blanco	SUITE-N
6349802	Plato ducha resina con desagüe 180 x 90 cm. negro	SUITE-N
6349823	Plato ducha resina con desagüe 180 x 90 cm. gris piedra	SUITE-N
6349824	Plato ducha resina con desagüe 180 x 90 cm. topo	SUITE-N
6349825	Plato ducha resina con desagüe 180 x 90 cm. moka	SUITE-N
6349826	Plato ducha resina con desagüe 180 x 90 cm. perla	SUITE-N
6349827	Plato ducha resina con desagüe 180 x 90 cm. gris claro	SUITE-N
6349828	Plato ducha resina con desagüe 180 x 90 cm. hormigón	SUITE-N
6349829	Plato ducha resina con desagüe 180 x 90 cm. gris oliva	SUITE-N
6349843	Plato ducha resina con desagüe 180 x 90 cm. arena	SUITE-N
6349844	Plato ducha resina con desagüe 180 x 90 cm. chocolate	SUITE-N
6349845	Plato ducha resina con desagüe 180 x 90 cm. gris plata	SUITE-N
6349850	Plato ducha resina con desagüe 180 x 90 cm. marfil	SUITE-N
6349882	Plato ducha resina con desagüe 180 x 90 cm. wengué	SUITE-N
6349884	Plato ducha resina con desagüe 180 x 90 cm. antracita	SUITE-N
6349901	Plato ducha resina con desagüe 200 x 90 cm. blanco	SUITE-N
6349902	Plato ducha resina con desagüe 200 x 90 cm. negro	SUITE-N
6349923	Plato ducha resina con desagüe 200 x 90 cm. gris piedra	SUITE-N
6349924	Plato ducha resina con desagüe 200 x 90 cm. topo	SUITE-N
6349925	Plato ducha resina con desagüe 200 x 90 cm. moka	SUITE-N
6349926	Plato ducha resina con desagüe 200 x 90 cm. perla	SUITE-N
6349927	Plato ducha resina con desagüe 200 x 90 cm. gris claro	SUITE-N
6349928	Plato ducha resina con desagüe 200 x 90 cm. hormigón	SUITE-N
6349929	Plato ducha resina con desagüe 200 x 90 cm. gris oliva	SUITE-N
6349943	Plato ducha resina con desagüe 200 x 90 cm. arena	SUITE-N
6349944	Plato ducha resina con desagüe 200 x 90 cm. chocolate	SUITE-N
6349945	Plato ducha resina con desagüe 200 x 90 cm. gris plata	SUITE-N
6349950	Plato ducha resina con desagüe 200 x 90 cm. marfil	SUITE-N
6349982	Plato ducha resina con desagüe 200 x 90 cm. wengué	SUITE-N
6349984	Plato ducha resina con desagüe 200 x 90 cm. antracita	SUITE-N
6347001	Plato ducha resina con desagüe corte 80-100/65-70 cm. blanco	SUITE-N
6347002	Plato ducha resina con desagüe corte 80-100/65-70 cm. negro	SUITE-N

6347023	Plato ducha resina con desagüe corte 80-100/65-70 cm. gris piedra	SUITE-N
6347024	Plato ducha resina con desagüe corte 80-100/65-70 cm. topo	SUITE-N
6347025	Plato ducha resina con desagüe corte 80-100/65-70 cm. moka	SUITE-N
6347026	Plato ducha resina con desagüe corte 80-100/65-70 cm. perla	SUITE-N
6347027	Plato ducha resina con desagüe corte 80-100/65-70 cm. gris claro	SUITE-N
6347028	Plato ducha resina con desagüe corte 80-100/65-70 cm. hormigón	SUITE-N
6347029	Plato ducha resina con desagüe corte 80-100/65-70 cm. gris oliva	SUITE-N
6347043	Plato ducha resina con desagüe corte 80-100/65-70 cm. arena	SUITE-N
6347044	Plato ducha resina con desagüe corte 80-100/65-70 cm. chocolate	SUITE-N
6347045	Plato ducha resina con desagüe corte 80-100/65-70 cm. gris plata	SUITE-N
6347050	Plato ducha resina con desagüe corte 80-100/65-70 cm. marfil	SUITE-N
6347082	Plato ducha resina con desagüe corte 80-100/65-70 cm. wengué	SUITE-N
6347084	Plato ducha resina con desagüe corte 80-100/65-70 cm. antracita	SUITE-N
6347101	Plato ducha resina con desagüe corte 101-110/65-70 cm. blanco	SUITE-N
6347102	Plato ducha resina con desagüe corte 101-110/65-70 cm. negro	SUITE-N
6347123	Plato ducha resina con desagüe corte 101-110/65-70 cm. gris piedra	SUITE-N
6347124	Plato ducha resina con desagüe corte 101-110/65-70 cm. topo	SUITE-N
6347125	Plato ducha resina con desagüe corte 101-110/65-70 cm. moka	SUITE-N
6347126	Plato ducha resina con desagüe corte 101-110/65-70 cm. perla	SUITE-N
6347127	Plato ducha resina con desagüe corte 101-110/65-70 cm. gris claro	SUITE-N
6347128	Plato ducha resina con desagüe corte 101-110/65-70 cm. hormigón	SUITE-N
6347129	Plato ducha resina con desagüe corte 101-110/65-70 cm. gris oliva	SUITE-N
6347143	Plato ducha resina con desagüe corte 101-110/65-70 cm. arena	SUITE-N
6347144	Plato ducha resina con desagüe corte 101-110/65-70 cm. chocolate	SUITE-N
6347145	Plato ducha resina con desagüe corte 101-110/65-70 cm. gris plata	SUITE-N
6347150	Plato ducha resina con desagüe corte 101-110/65-70 cm. marfil	SUITE-N
6347182	Plato ducha resina con desagüe corte 101-110/65-70 cm. wengué	SUITE-N
6347184	Plato ducha resina con desagüe corte 101-110/65-70 cm. antracita	SUITE-N
6347201	Plato ducha resina con desagüe corte 111-120/65-70 cm. blanco	SUITE-N
6347202	Plato ducha resina con desagüe corte 111-120/65-70 cm. negro	SUITE-N
6347223	Plato ducha resina con desagüe corte 111-120/65-70 cm. gris piedra	SUITE-N
6347224	Plato ducha resina con desagüe corte 111-120/65-70 cm. topo	SUITE-N
6347225	Plato ducha resina con desagüe corte 111-120/65-70 cm. moka	SUITE-N
6347226	Plato ducha resina con desagüe corte 111-120/65-70 cm. perla	SUITE-N
6347227	Plato ducha resina con desagüe corte 111-120/65-70 cm. gris claro	SUITE-N
6347228	Plato ducha resina con desagüe corte 111-120/65-70 cm. hormigón	SUITE-N
6347229	Plato ducha resina con desagüe corte 111-120/65-70 cm. gris oliva	SUITE-N
6347243	Plato ducha resina con desagüe corte 111-120/65-70 cm. arena	SUITE-N
6347244	Plato ducha resina con desagüe corte 111-120/65-70 cm. chocolate	SUITE-N
6347245	Plato ducha resina con desagüe corte 111-120/65-70 cm. gris plata	SUITE-N
6347250	Plato ducha resina con desagüe corte 111-120/65-70 cm. marfil	SUITE-N
6347282	Plato ducha resina con desagüe corte 111-120/65-70 cm. wengué	SUITE-N
6347284	Plato ducha resina con desagüe corte 111-120/65-70 cm. antracita	SUITE-N
6347301	Plato ducha resina con desagüe corte 121-130/65-70 cm. blanco	SUITE-N
6347302	Plato ducha resina con desagüe corte 121-130/65-70 cm. negro	SUITE-N
6347323	Plato ducha resina con desagüe corte 121-130/65-70 cm. gris piedra	SUITE-N









6349228	Plato ducha resina con desagüe corte 101-120/81-90 cm. hormigón	SUITE-N
6349229	Plato ducha resina con desagüe corte 101-120/81-90 cm. gris oliva	SUITE-N
6349243	Plato ducha resina con desagüe corte 101-120/81-90 cm. arena	SUITE-N
6349244	Plato ducha resina con desagüe corte 101-120/81-90 cm. chocolate	SUITE-N
6349245	Plato ducha resina con desagüe corte 101-120/81-90 cm. gris plata	SUITE-N
6349250	Plato ducha resina con desagüe corte 101-120/81-90 cm. marfil	SUITE-N
6349282	Plato ducha resina con desagüe corte 101-120/81-90 cm. wengué	SUITE-N
6349284	Plato ducha resina con desagüe corte 101-120/81-90 cm. antracita	SUITE-N
6349401	Plato ducha resina con desagüe corte 121-140/81-90 cm. blanco	SUITE-N
6349402	Plato ducha resina con desagüe corte 121-140/81-90 cm. negro	SUITE-N
6349423	Plato ducha resina con desagüe corte 121-140/81-90 cm. gris piedra	SUITE-N
6349424	Plato ducha resina con desagüe corte 121-140/81-90 cm. topo	SUITE-N
6349425	Plato ducha resina con desagüe corte 121-140/81-90 cm. moka	SUITE-N
6349426	Plato ducha resina con desagüe corte 121-140/81-90 cm. perla	SUITE-N
6349427	Plato ducha resina con desagüe corte 121-140/81-90 cm. gris claro	SUITE-N
6349428	Plato ducha resina con desagüe corte 121-140/81-90 cm. hormigón	SUITE-N
6349429	Plato ducha resina con desagüe corte 121-140/81-90 cm. gris oliva	SUITE-N
6349443	Plato ducha resina con desagüe corte 121-140/81-90 cm. arena	SUITE-N
6349444	Plato ducha resina con desagüe corte 121-140/81-90 cm. chocolate	SUITE-N
6349445	Plato ducha resina con desagüe corte 121-140/81-90 cm. gris plata	SUITE-N
6349450	Plato ducha resina con desagüe corte 121-140/81-90 cm. marfil	SUITE-N
6349482	Plato ducha resina con desagüe corte 121-140/81-90 cm. wengué	SUITE-N
6349484	Plato ducha resina con desagüe corte 121-140/81-90 cm. antracita	SUITE-N
6349601	Plato ducha resina con desagüe corte 141-160/81-90 cm. blanco	SUITE-N
6349602	Plato ducha resina con desagüe corte 141-160/81-90 cm. negro	SUITE-N
6349623	Plato ducha resina con desagüe corte 141-160/81-90 cm. gris piedra	SUITE-N
6349624	Plato ducha resina con desagüe corte 141-160/81-90 cm. topo	SUITE-N
6349625	Plato ducha resina con desagüe corte 141-160/81-90 cm. moka	SUITE-N
6349626	Plato ducha resina con desagüe corte 141-160/81-90 cm. perla	SUITE-N
6349627	Plato ducha resina con desagüe corte 141-160/81-90 cm. gris claro	SUITE-N
6349628	Plato ducha resina con desagüe corte 141-160/81-90 cm. hormigón	SUITE-N
6349629	Plato ducha resina con desagüe corte 141-160/81-90 cm. gris oliva	SUITE-N
6349643	Plato ducha resina con desagüe corte 141-160/81-90 cm. arena	SUITE-N
6349644	Plato ducha resina con desagüe corte 141-160/81-90 cm. chocolate	SUITE-N
6349645	Plato ducha resina con desagüe corte 141-160/81-90 cm. gris plata	SUITE-N
6349650	Plato ducha resina con desagüe corte 141-160/81-90 cm. marfil	SUITE-N
6349682	Plato ducha resina con desagüe corte 141-160/81-90 cm. wengué	SUITE-N
6349684	Plato ducha resina con desagüe corte 141-160/81-90 cm. antracita	SUITE-N
6349801	Plato ducha resina con desagüe corte 161-180/81-90 cm. blanco	SUITE-N
6349802	Plato ducha resina con desagüe corte 161-180/81-90 cm. negro	SUITE-N
6349823	Plato ducha resina con desagüe corte 161-180/81-90 cm. gris piedra	SUITE-N
6349824	Plato ducha resina con desagüe corte 161-180/81-90 cm. topo	SUITE-N
6349825	Plato ducha resina con desagüe corte 161-180/81-90 cm. moka	SUITE-N
6349826	Plato ducha resina con desagüe corte 161-180/81-90 cm. perla	SUITE-N

6349827	Plato ducha resina con desagüe corte 161-180/81-90 cm. cm. gris claro	SUITE-N
6349828	Plato ducha resina con desagüe corte 161-180/81-90 cm. cm. hormigón	SUITE-N
6349829	Plato ducha resina con desagüe corte 161-180/81-90 cm. cm. gris oliva	SUITE-N
6349843	Plato ducha resina con desagüe corte 161-180/81-90 cm. cm. arena	SUITE-N
6349844	Plato ducha resina con desagüe corte 161-180/81-90 cm. cm. chocolate	SUITE-N
6349845	Plato ducha resina con desagüe corte 161-180/81-90 cm. gris plata	SUITE-N
6349850	Plato ducha resina con desagüe corte 161-180/81-90 cm. marfil	SUITE-N
6349882	Plato ducha resina con desagüe corte 161-180/81-90 cm. wengué	SUITE-N
6349884	Plato ducha resina con desagüe corte 161-180/81-90 cm. antracita	SUITE-N
6349901	Plato ducha resina con desagüe corte 181-200/81-90 cm. blanco	SUITE-N
6349902	Plato ducha resina con desagüe corte 181-200/81-90 cm. negro	SUITE-N
6349923	Plato ducha resina con desagüe corte 181-200/81-90 cm. gris piedra	SUITE-N
6349924	Plato ducha resina con desagüe corte 181-200/81-90 cm. topo	SUITE-N
6349925	Plato ducha resina con desagüe corte 181-200/81-90 cm. moka	SUITE-N
6349926	Plato ducha resina con desagüe corte 181-200/81-90 cm. perla	SUITE-N
6349927	Plato ducha resina con desagüe corte 181-200/81-90 cm. gris claro	SUITE-N
6349928	Plato ducha resina con desagüe corte 181-200/81-90 cm. hormigón	SUITE-N
6349929	Plato ducha resina con desagüe corte 181-200/81-90 cm. gris oliva	SUITE-N
6349943	Plato ducha resina con desagüe corte 181-200/81-90 cm. arena	SUITE-N
6349944	Plato ducha resina con desagüe corte 181-200/81-90 cm. chocolate	SUITE-N
6349945	Plato ducha resina con desagüe corte 181-200/81-90 cm. gris plata	SUITE-N
6349950	Plato ducha resina con desagüe corte 181-200/81-90 cm. marfil	SUITE-N
6349982	Plato ducha resina con desagüe corte 181-200/81-90 cm. wengué	SUITE-N
6349984	Plato ducha resina con desagüe corte 181-200/81-90 cm. antracita	SUITE-N

## Mamparas

Referencia	Descripción	Serie
8926000	Mampara frontal fijo de 70 cm.	WALK-IN N
8926100	Mampara frontal fijo de 80 cm.	WALK-IN N
8926200	Mampara frontal fijo de 90 cm.	WALK-IN N
8926300	Mampara frontal fijo de 100 cm.	WALK-IN N
8926400	Mampara frontal fijo de 110 cm.	WALK-IN N
8926500	Mampara frontal fijo de 120 cm.	WALK-IN N
8927000	Mampara frontal fijo de 70 cm. + puerta mano derecha	WALK-IN N
8927100	Mampara frontal fijo de 80 cm. + puerta mano derecha	WALK-IN N
8927200	Mampara frontal fijo de 90 cm. + puerta mano derecha	WALK-IN N
8927300	Mampara frontal fijo de 100 cm. + puerta mano derecha	WALK-IN N
8927400	Mampara frontal fijo de 110 cm. + puerta mano derecha	WALK-IN N
8927500	Mampara frontal fijo de 120 cm. + puerta mano derecha	WALK-IN N
8928000	Mampara frontal fijo de 70 cm. + puerta mano izquierda	WALK-IN N
8928100	Mampara frontal fijo de 80 cm. + puerta mano izquierda	WALK-IN N
8928200	Mampara frontal fijo de 90 cm. + puerta mano izquierda	WALK-IN N
8928300	Mampara frontal fijo de 100 cm. + puerta mano izquierda	WALK-IN N
8928400	Mampara frontal fijo de 110 cm. + puerta mano izquierda	WALK-IN N
8928500	Mampara frontal fijo de 120 cm. + puerta mano izquierda	WALK-IN N

8929000	Mampara cristal lateral fijo de 70 cm.	WALK-IN N
8929100	Mampara cristal lateral fijo de 80 cm.	WALK-IN N
8929200	Mampara cristal lateral fijo de 90 cm.	WALK-IN N

## Bañeras

Referencia	Descripción	Serie
6012301	Bañera 170 x 70 cm. con sistema emotive essential	NILA
6022301	Bañera 160 x 70 cm. con sistema emotive essential	NILA
6032301	Bañera 150 x 70 cm. con sistema emotive essential	NILA
6042301	Bañera 140 x 70 cm. con sistema emotive essential	NILA
6052301	Bañera 170 x 75 cm. con sistema emotive essential	NILA
6062301	Bañera 160 x 75 cm. con sistema emotive essential	NILA
6199001	Bañera 135 x 135 cm. sensitive smart comfort dorsal	TREVO
6241901	Bañera 170 x 75 cm. con sistema sensitive smart comfort dorsal	MITTA
6249201	Bañera 170 x 80 cm. con sistema sensitive smart comfort dorsal	MITTA
6261901	Bañera 170 x 70 cm. con sistema sensitive smart comfort dorsal	MITTA
6268201	Bañera 180 x 80 cm. con sistema sensitive smart comfort dorsal	MITTA
6415301	Bañera 180 x 80 cm. con sistema sensitive smart comfort dorsal	EMMA
6425301	Bañera 170 x 80 cm. con sistema sensitive smart comfort dorsal	EMMA
6435301	Bañera 170 x 75 cm. con sistema sensitive smart comfort dorsal	EMMA

EDICIÓN ENERO 2024

**gala**

Cerámicas Gala S.A

Ctra. Madrid-Irún Km 244 09007 Burgos  
T:+34 947 47 41 00 F:+34 947 47 41 03

[general@gala.es](mailto:general@gala.es)

[www.gala.es](http://www.gala.es)